

GUIA PROFESIONAL

El tornillo correcto
para cada aplicación.

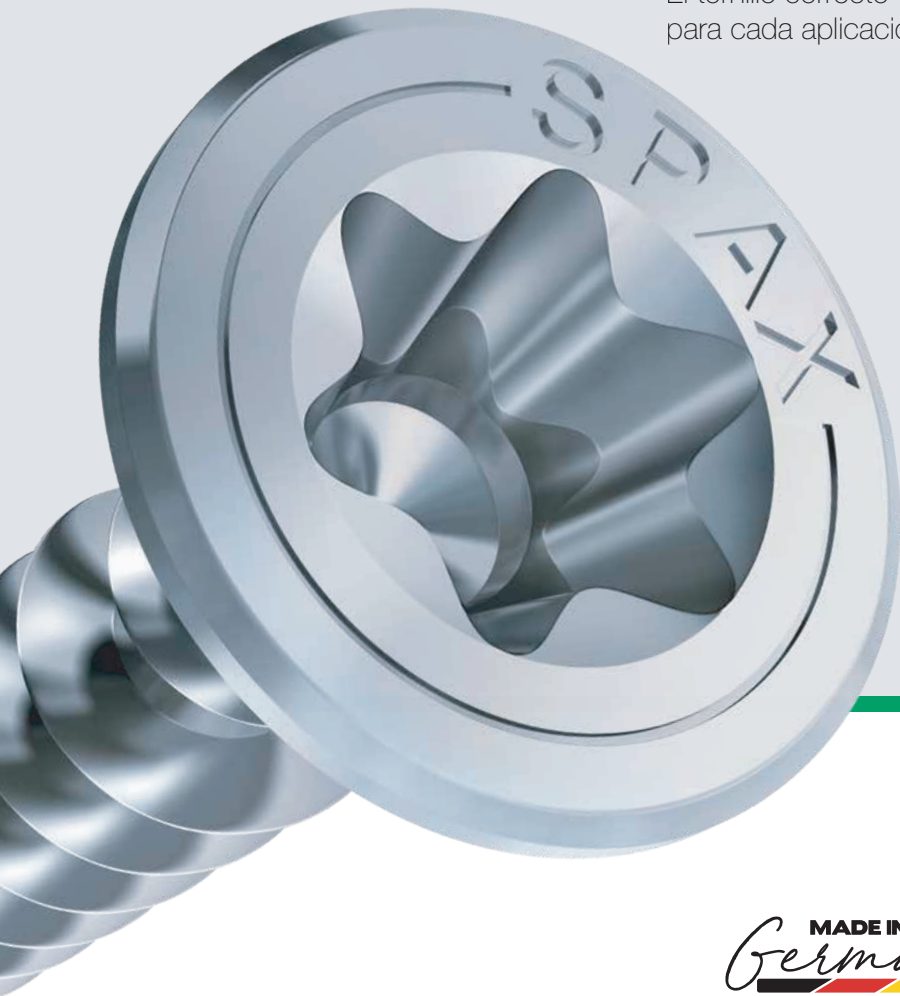

**GAMA DE PRODUCTOS
SPAX 4-125****Breve resumen** 4-21**Cabeza plana** 22-81**Cabeza redonda** 82-93**Cabeza gota de
sebo** 94-101**Cabeza con
arandela** 102-109**Cabeza cilíndrica** 110-117**Vástago roscado** 118-119**Sin cabeza** 120-121**Cabeza de
centrado** 122-123**Cabeza decorativa** 124-125**MALETINES 126-135****SPAX
L-BOXX** 128-131**SPAX
GREEN BOX** 132-133**SPAX 134-135
Apilamiento modular****TACOS SPAX 136-139****SPAX
Taco** 138**SPAX
Taco + tornillo** 139**ACCESORIOS 140-157****Programa BIT** 142-144**Kits** 145-147**Material para
construcción madera** 148**Accesorios
para terraza** 150-155**Tapones de
plástico** 156-157**RESUMEN****PRODUCTOS**



GAMA FEX - PARA VENTANAS 158-173	
Cabeza Plana	160-165
Cabeza especial	166-167
Cabeza con encaje	168-169
Cabeza cilíndrica	170-171
Cabeza extraplana	172-173

DESCUBRE SPAX 180-193	
Datos & Cifras	180-188
Videos	189
Descargas	190-191
Certificados	192-193

TERMINOS GENERALES Y CONDICIONES 194 -197
--

GAMA GIX 174-179	
TIPO A	176
TIPO B	177
TIPO C	178
TIPO D	179

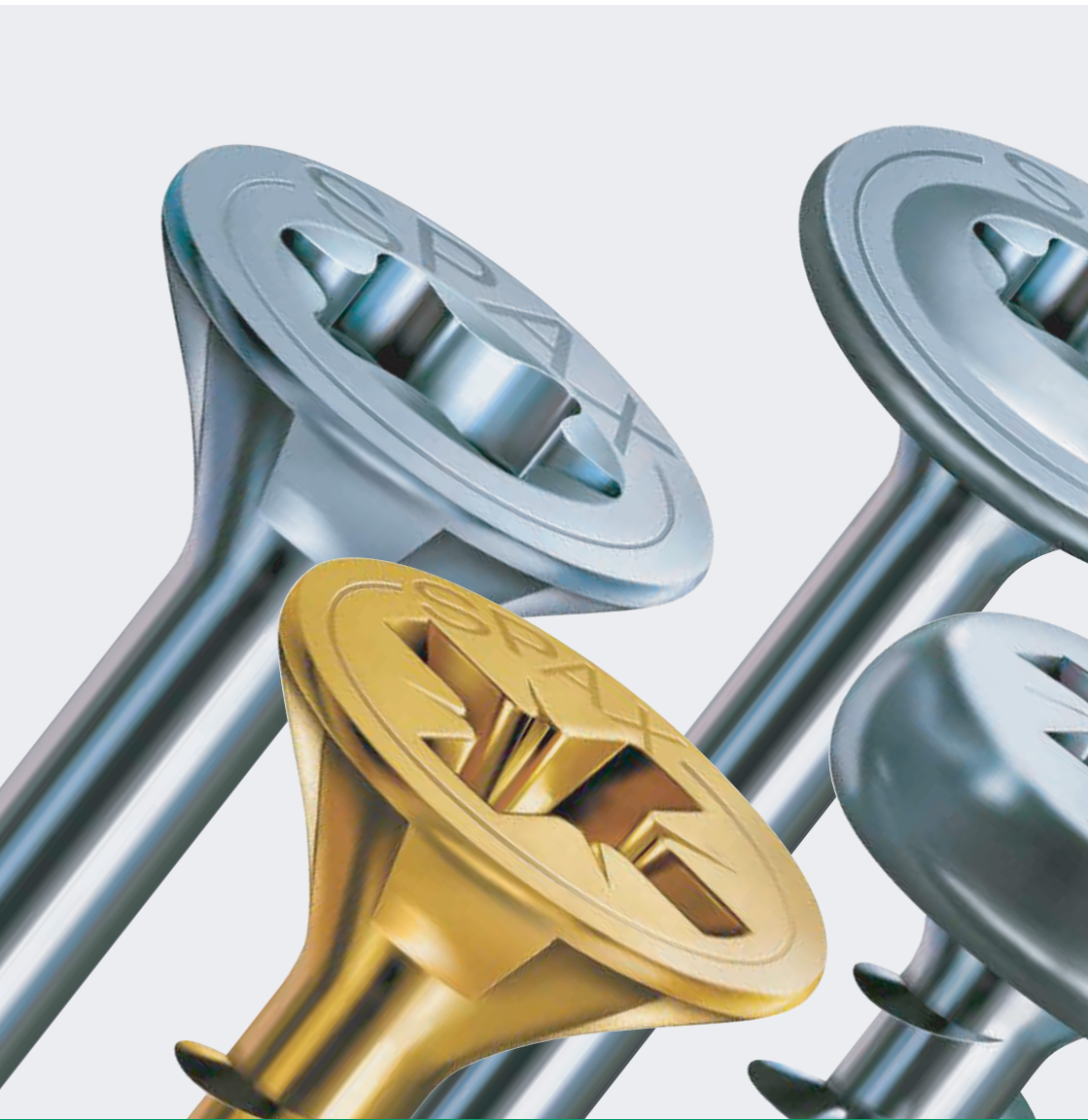

BREVE RESUMEN





Breve resumen – tornillo universal , cabeza plana

T-STAR *plus* o ranura en cruz Z, rosca completa/parcial

WIROX

A9J

Gama de producto con embalaje estándar

Longitud [mm]	Ø d ₁ [mm]						
	2.5	3.0	3.5	4.0	4.5	5.0	6.0
	Ø d _k [mm]		Ø d _k [mm]		Ø d _k [mm]		Ø d _k [mm]
	5.1	6.0	7.0	8.0	8.8	9.7	11.6
10	●	●					
12	●	● ■	●	●			
13		●	●				
15		●	● ■	● ■			
16	●	● ■	● ■	● ■	● ■	●	
17		●	●	●			
20	●	● ■	● ■	● ■	● ■	● ■	
25	●	● ■	● ■	● ■	● ■	● ■	
30		● ■ □	● ○ ■ □	● ○ ■ □	● ■ □	● ■ □	●
35		● □	● ○ ■ □	● ○ ■ □	● ○ ■ □	● ■ □	●
40		● □	● ○ ■ □	● ○ ■ □	● ○ ■ □	● ○ ■ □	● ■ □
45		●	● ○ ■ □	● ○ ■ □	● ○ ■ □	● ○ ■ □	● ■ □
50			● ○ □	● ○ ■ □	● ○ ■ □	● ○ ■ □	● ■ □
55				● ○	● ○	● ○ □	
60				● ○ □	● ○ ■ □	● ○ ■ □	● ○ ■ □
65						○	
70				● □	● ○ ■ □	● ○ ■ □	● ○ ■ □
80				● □	● □	● ○ ■ □	● ○ ■ □
90						○ □	○ □
100						○ □	○ □
110						○	□
120						○ □	○ □
130							□
140							○ □
150							□
160							○ □
180							□
200							□
220							□
240							□
260							□
280							□
300							□

■ T-STAR *plus*, rosca completa
□ T-STAR *plus*, rosca parcial

● Ranura en cruz Z, rosca completa
○ Ranura en cruz Z, rosca parcial

Ø d₁ = Diámetro de rosca en mm
Ø d_k = Diámetro de cabeza en mm



Breve resumen – tornillo universal , cabeza plana
T-STAR *plus* o ranura en cruz Z, rosca completa/parcial



Gama de producto con embalaje pequeño						
Longitud [mm]	Ø d ₁ [mm]					
	3.0	3.5	4.0	4.5	5.0	6.0
	Ø d _k [mm]					
	6.0	7.0	8.0	8.8	9.7	11.6
12	● ■	● ■	●			
16	● ■	● ■	●	●		
20	● ■	● ■	●	●	●	
25	● ■	● ■	● ■	●	●	
30	● ■	● ■ □	● ■ □	● ■ □	● ■ □	
35	●	● ■ □	● ■ □	● ■ □	● ■ □	
40	●	● ■ □	● ■ □	● ■ □	● ■ □	●
45		● ■ □	● ■ □	● ■ □	● ■ □	
50		● □	● ■ □	● ■ □	● ■ □	● ■ □
55						
60			● □	● ■ □	● ■ □	● ■ □
65						
70			● □	● ■ □	● ■ □	● ■ □
80				● □	● ■ □	● ■ □
90					○ □	○ □
100					○ □	○ □

■ T-STAR *plus*, rosca completa
□ T-STAR *plus*, rosca parcial

● Ranura en cruz Z, rosca completa
○ Ranura en cruz Z, rosca parcial

Ø d₁ = Diámetro de rosca en mm
Ø d_k = Diámetro de cabeza en mm





**Breve resumen – tornillos para construcciones de madera,
cabeza plana, T-STAR plus, rosca completa/parcial**

WIROX®

A9J

Gama de producto con embalaje estándar

Longitud [mm]	Ø d ₁ [mm]			
	8.0		10.0	
	15.1		18.6	
	Ø d _k [mm]		12.0	
			22.6	18.6
80	☐		☐	
100	☐		☐	
120	☐	■	☐	■
140	☐	■	☐	
160	☐	■	☐	■
180	☐	■	☐	
200	☐	■	☐	■
220	☐	■	☐	■
240	☐	■	☐	■
260	☐	■	☐	■
280	☐	■	☐	■
300	☐	■	☐	■
320	☐		☐	
340	☐		☐	
350		■		■
360	☐		☐	
380	☐		☐	
400	☐	■	☐	■
450	☐	■	☐	■
500		■		■
550		■		■
600		■		■
700			■	■
800			■	

- T-STAR plus, rosca completa
- ☐ T-STAR plus, rosca parcial

- Ø d₁ = Diámetro de rosca en mm
- Ø d_k = Diámetro de cabeza en mm

NUEVO



Breve resumen – tornillo universal, cabeza plana

T-STAR *plus* o ranura en cruz Z, rosca completa/parcial

YELLOX®

**CHROM(VI)
FREE**

A2L

Gama de producto con embalaje estándar

Longitud [mm]	Ø d ₁ [mm]							
	2.0	2.5	3.0	3.5	4.0	4.5	5.0	6.0
	Ø d _k [mm]							
	4.3	5.1	6.0	7.0	8.0	8.8	9.7	11.6
10	●	●	●					
12	●	●	● ■	●	●			
15				●	●			
16	●	●	● ■	● ■	●	●		
17								
20		●	● ■	● ■	● ■	●	●	
25		●	● ■	● ■	● ■	●	●	
30			● □	● □	● □	● □	● □	●
35			● □	● ○ □	● ○ □	● □	● □	●
40			● □	● ○ □	● ○ □	● ○ □	● □	●
45		●		● ○ □	● ○ □	● ○ □	● □	●
50				● ○ □	● ○ □	● ○ □	● ○ □	●
55					● ○		□	
60					● ○ □	● ○ □	● ○ □	● ○ □
70					● □	● ○ □	● ○ □	● ○ □
80					● □	● □	● ○ □	● ○ □
90							○ □	○ □
100							○ □	○ □
110							○ □	□
120							○ □	○ □
130								□
140								○ □
150								□
160								○ □
180								○ □
200								□
220								□
240								□
260								□
280								□
300								□

■ T-STAR *plus*, rosca completa

● Ranura en cruz Z, rosca completa

□ T-STAR *plus*, rosca parcial

○ Ranura en cruz Z, rosca parcial

Ø d₁ = Diámetro de rosca en mm

Ø d_k = Diámetro de cabeza en mm

Artículo descatálogo



Breve resumen – tornillo universal, cabeza plana
T-STAR *plus* o ranura en cruz Z, rosca completa/parcial



Gama de producto con embalaje pequeño						
Longitud [mm]	Ø d ₁ [mm]					
	3.0	3.5	4.0	4.5	5.0	6.0
	Ø d _k [mm]					
	6.0	7.0	8.0	8.8	9.7	11.6
12	● ■	●				
16	● ■	●	●	●		
20	● ■	●	● ■	●	●	
25	● ■	● ■	● ■	●	●	
30	●	● □	● □	● □	● □	
35	●	● □	● □	● □	● □	
40	●	● □	● □	● □	● □	●
45		●	● □	● □	● □	
50		● □	● □	● □	● □	● □
60			● □	● □	● □	● □
70			● □	● □	● □	● □
80				● □	● ○ □	● □
90					○ □	○ □
100					○ □	

■ T-STAR *plus*, rosca completa
□ T-STAR *plus*, rosca parcial

● Ranura en cruz Z, rosca completa
○ Ranura en cruz Z, rosca parcial
Ø d₁ = Diámetro de rosca en mm
Ø d_k = Diámetro de cabeza en mm





Breve resumen – tornillo universal, cabeza plana,
T-STAR *plus* o ranura en cruz Z, rosca completa/parcial

Acero inoxidable A2 1.4567

A2
AISI 304

Gama de producto en embalaje pequeño A2 1.4567

Longitud [mm]	Ø d ₁ [mm]						
	3.0	3.5	4.0	4.5	5.0	6.0	8.0
	Ø d _k [mm]						
	6.0	7.0	8.0	8.8	9.7	11.6	15.1
12	●	■					
16	●	■	●	■			
20	●	■	●	■			
25	●	■	●	■	●	■	
30	●	■	●	■	□		
35		●	■	□	●	■	
40	●	■	●	■	□	●	■
45			●	■	□	●	■
50			●	■	□	●	■
60			●	■	□	●	■
70			●	■	□	●	■
80					●	■	□
90						○	□
100					○	□	□
120						□	□
140							□
160							□
180							□
200							□
220							□
240							□
260							□
280							□
300							□

■ T-STAR *plus*, rosca completa ● Ranura en cruz Z, rosca completa Ø d₁ = Diámetro de rosca en mm
□ T-STAR *plus*, rosca parcial ○ Ranura en cruz Z, rosca parcial Ø d_k = Diámetro de cabeza en mm

NUEVO





Breve resumen – tornillos de construcción en madera, cabeza plana,
T-STAR *plus*, rosca completa

Acero inoxidable A4 1.4578

A4
AISI 316

Gama de producto embalaje estándar A4 1.4578			
Longitud [mm]	Ø d ₁ [mm]		12.0
	10.0	18.6	
	Ø d _k [mm]		18.6
160	■		
200	■		
220	■		
240	■		
260	■		
280	■		
300	■		
350	■		
400	■		■
450			■
500			■
550			■

■ T-STAR *plus*, rosca completa

Ø d₁ = Diámetro de rosca en mm

Ø d_k = Diámetro de cabeza en mm





Breve resumen – tornillo universal, cabeza redonda
T-STAR *plus* o ranura en cruz Z, rosca completa/parcial

WIROX®

A9J



Gama de producto embalaje estándar

Longitud [mm]	Ø d ₁ [mm]					
	3.0	3.5	4.0	4.5	5.0	6.0
	Ø d _k [mm]					
	6.0	7.0	8.0	9.0	9.9	11.6
10	●					
12	●	● ■	● ■	● ■		
15	●	● ■	● ■	● ■	●	
16	●	● ■	● ■	● ■	● ■	
20	●	● ■	● ■	● ■	● ■	■
25	●	● ■	● ■	● ■	● ■	● ■
30	●	● ■	● ■	● ■	● ■	● ■
35		● ■	● ■	● ■	● ■	● ■
40		●	● ■	● ■	● ■	● ■
45			●	● ■	●	
50			● ■	● ■	● ■	● ■
60			● ■	● ■	● ■	● ■
70					● ■	● ■
80					● ■	● ■
90					○ □	○ □
100						□

■ T-STAR *plus*, rosca completa ● Ranura en cruz Z, rosca completa Ø d₁ = Diámetro de rosca en mm
□ T-STAR *plus*, rosca parcial ○ Ranura en cruz Z, rosca parcial Ø d_k = Diámetro de cabeza en mm

Gama de producto embalaje pequeño

Longitud [mm]	Ø d ₁ [mm]				
	3.0	4.0	4.5	5.0	6.0
	Ø d _k [mm]				
	6.0	8.0	9.0	9.9	11.6
12	■				
16	■	■			
20	■	■	■	■	
25		■	■	■	
30		■	■	■	
35		■	■	■	
40		■	■	■	■
45		■	■		
50		■	■	■	■
60				■	
70				■	
80				■	

■ T-STAR *plus*, rosca completa Ø d₁ = Diámetro de rosca en mm Ø = Diámetro de rosca en mm



Breve resumen – tornillo universal, cabeza redonda,
T-STAR *plus*, rosca completa

Acero inoxidable A2 1.4567

A2
AISI 304

Gama de producto embalaje pequeño A2 1.4567				
Longitud [mm]	Ø d ₁ [mm]			
	3.0	3.5	4.0	5.0
	Ø d _k [mm]			
	6.0	7.0	8.0	9.9
20	■	■	■	
25			■	■
30	■	■	■	■
35			■	
40			■	■
45			■	
50			■	■

■ T-STAR *plus*, rosca completa Ø d₁ = Diámetro de rosca en mm

Ø d_k = Cabeza de diámetro en mm





Breve resumen – tornillo universal, cabeza gota de sebo

Ranura en cruz Z, rosca completa

WIROX

A9J



Gama de producto embalaje estándar			
Longitud [mm]	Ø d ₁ [mm]		4.0
	3.5	7.0	
	Ø d _k [mm]		8.0
15	●		
16	●		●
20	●		●
25	●		●
30	●		●
35			●

● Ranura en cruz Z, rosca completa Ø d₁ = Diámetro de rosca en mm Ø d_k = Diámetro de cabeza en mm

Breve resumen– tornillo universal, cabeza gota de sebo,

Ranura en cruz Z, rosca completa

Nickel

E1J



Gama de producto embalaje estándar			
Longitud [mm]	Ø d ₁ [mm]		4.0
	3.5	7.0	
	Ø d _k [mm]		8.0
16	●		●
20	●		●
25	●		●
30	●		●
35			●

● Ranura en cruz Z, rosca completa Ø d₁ = Diámetro de rosca en mm Ø d_k = Diámetro de cabeza en mm



Breve resumen – tornillo universal, cabeza gota sebo,
T-STAR *plus*, rosca completa

Acero inoxidable A2 1.4567

A2
AISI 304

Gama de producto embalaje pequeño A2 1.4567				
Longitud [mm]	Ø d ₁ [mm]			
	3.0*	3.5	4.0	4.5
	Ø d _k [mm]			
	6.0	7.0	8.0	8.8
16		■		
20	■	■		
25	■			
30		■	■	
40			■	
45			■	
50				■

■ T-STAR *plus*, rosca completa Ø d₁ = Diámetro de rosca en mm Ø d_k = Diámetro de cabeza en mm

*Versión divergente.



Breve resumen – tornillo universal, gota de sebo,
T-STAR *plus*, rosca completa

Acero inoxidable A2 1.4567

A2
AISI 304

Resumen de gama de productos SPAX para fachadas							
Ls (mm)							
	Ø d _k = 8 mm	Ø d _k = 8 mm	Ø d _k = 8.8 mm	Ø d _k = 9.7 mm	Ø d _k = 6 mm	Ø d _k = 7 mm	Ø d _k = 8 mm
Ø d ₁	4.5	4.5	4.5	5.0	4.0	4.5	5.0
35			□				
40			□		□		
45			□		□		
50	■	■	□				
60	■	■	□	□	□		
70	■		□	□		□	
80			□	□			
90				□			
100				□			□

□ T-STAR *plus*, rosca parcial Ø d₁ = Diámetro de rosca en mm Ø d_k = Diámetro de cabeza en mm

■ T-STAR *plus*, rosca de fijación





Breve resumen – tornillo universal, cabeza arandela,
Ranura en cruz Z, rosca completa

WIROX®

A9J



Gama de producto embalaje estándar				
Longitud [mm]	Ø d ₁ [mm]			
	3.5	4.0	4.5	5.0
	Ø d _k [mm]			
	8.6	9.6	10.6	11.6
13		●		
17	●	●		
20	●	●	●	●
25	●	●	●	●
30	●	●	●	●
35	●	●	●	●
40		●	●	●
45		●	●	●
50			●	●
60				●

● Ranura en cruz Z, rosca completa Ø d₁ = Diámetro de rosca en mm Ø d_k = Diámetro de cabeza en mm

Breve resumen – tornillo universal, cabeza arandela extraplana
T-STAR *plus*, rosca completa

WIROX®

A9J



Gama de producto embalaje estándar			
Longitud [mm]	Ø d ₁ [mm]		
	3.0	3.5	4.0
	Ø d _k [mm]		
	7.9	8.7	10.0
16			■
20	■		■
25	■	■	■
30	■	■	
40		■	

■ T-STAR *plus*, rosca completa Ø d₁ = Diámetro de rosca en mm Ø d_k = Diámetro de cabeza en mm *con punta CUT para MDF

Breve resumen – tornillo universal, cabeza arandela extraplana
T-STAR *plus*, rosca parcial

Nickel

E1J



Gama de producto embalaje estándar	
Longitud [mm]	Ø d ₁ [mm]
	4.0
	Ø d _k [mm]
	10.0
30	□
34	□

□ T-STAR *plus*, rosca parcial Ø d₁ = Diámetro de rosca en mm Ø d_k = Diámetro de cabeza en mm

NUEVO



Breve resumen – tornillo universal y para construcciones de madera,
T-STAR *plus*, rosca completa/parcial



A9J

Gama de producto embalaje estándar				
Longitud [mm]	Ø d ₁ [mm]			
	5.0	6.0	8.0	10.0
	Ø d _k [mm]			
	11.6	13.6	20.0	25.0
40		■		
50			■*	
60		■		
77	□			
80		■	■	■
87	□			
100		□	■	■
107	□			
120		□	■	■
140		□	□	□
160		□	□	□
180		□	□	□
200		□	□	□
220		□	□	□
240			□	□
250		□		
260			□	□
280		□	□	□
300		□	□	□
320			□	□
340			□	□
360			□	□
380			□	□
400			□	□
450			□	□
500			□	
550			□	

- T-STAR *plus*, rosca completa
- T-STAR *plus*, rosca parcial

Ø d₁ = Diámetro de rosca en mm
Ø d_k = Diámetro de cabeza en mm

*Acabado diferente: P5J.



NUEVO



Breve resumen – tornillos para la construcción en madera, cabeza arandela T-STAR plus, rosca completa/parcial

Acero inoxidable A2 1.4567

A2
ANSI 304



Gama de producto embalaje estándar A2 1.4567			
Longitud [mm]	Ø d ₁ [mm]		
	6.0		8.0
	Ø d _k [mm]		
	13.6		20.0
50			■
60	■		■
80	■		■
100	□		■
120	□		■
140	□		□
160			□
180			□
200			□
220			□
240			□
260			□
280			□
300			□

- T-STAR plus, rosca completa
- T-STAR plus, rosca parcial

Ø d₁ = Diámetro de rosca en mm

Ø d_k = Cabeza de diámetro en mm

NUEVO





Breve resumen – Tornillos para la construcción en madera, cabeza cilíndrica, T-STAR *plus*, rosca completa



Gama de producto embalaje estándar			
Longitud [mm]	Ø d ₁ [mm]		
	6.0	8.0	
	Ø d _k [mm]		
	8.4	10.0	
80	■		
100	■		
120	■		
140	■		
160	■		■
180	■		■
200	■		■
220			■
240			■
260			■
280			■
300			■
350			■
400			■
450			■
500			■
550			■
600			■

■ T-STAR *plus*, rosca completa

Ø d₁ = Diámetro de rosca en mm

Ø d_k = Diámetro de cabeza en mm

NUEVO



Cabeza plana	24-81
- WIROX	26-49
- YELLOX	50-67
- BRONCE	68-70
- ACERO INOXIDABLE A2	72-79
- ACERO INOXIDABLE A4	80-81

Cabeza redonda	82-93
- WIROX	84-91
- ACERO INOXIDABLE A2	92

Cabeza gota de sebo	94-101
- WIROX	96
- NIQUEL	97
- ACERO INOXIDABLE A2	98-101
- ACERO INOXIDABLE A2 bronce	100

Cabeza arandela	102-109
- WIROX Cabeza arandela	104
- WIROX Cabeza arandela extra plana	105
- WIROX Tornillo de ajuste	106
- WIROX Tornillo Unión	107-108
- ACERO INOXIDABLE A2	109

Cabeza cilíndrica	110-117
- WIROX	112-113
- ACERO INOXIDABLE A2	114-115
- ACERO INOXIDABLE A2 bronce	114
- ACERO INOXIDABLE A4	116-117

Vástago roscado	118-119
- GALVANIZADO.....	119

Sin cabeza	120-121
- GALVANIZADO.....	121
- ACERO INOXIDABLE A2.....	121

Cabeza de centrado	122-123
- ACERO INOXIDABLE A1	123

Cabeza decorativa	124-125
- ACERO INOXIDABLE A2	125

SPAX Sets	126-135
------------------	----------------

SPAX Taco	136-139
------------------	----------------

Accesorios SPAX	140-157
- Programa BIT	142-144
- Sistemas de ordenación	145-147
- Accesorios para madera	148
- Accesorios para terraza	150-155
- Tapones de plástico	156-157

RESUMEN

GAMA DE PRODUCTOS



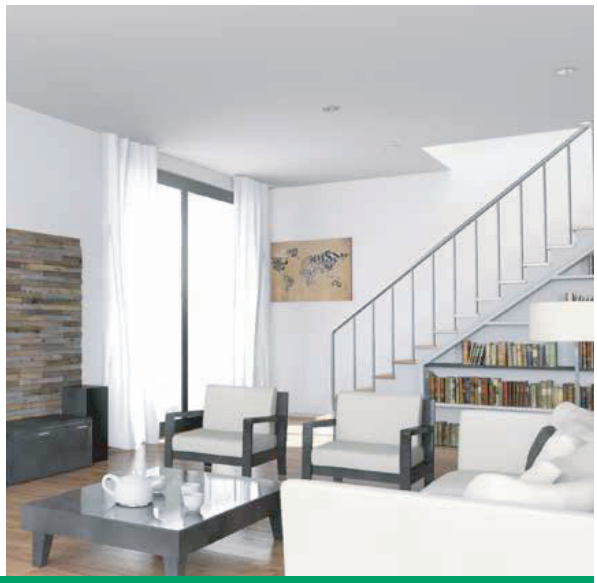

Toda la gama SPAX está organizada según su material, tipo de cabeza o acabado para que usted pueda identificar el SPAX correcto para la aplicación deseada.

Desde el tornillo SPAX con cabeza plana hasta nuestros tornillos con cabeza arandela, en acero inoxidable o con acabado WIROX. SPAX es siempre la mejor opción.

Cabeza plana 24-81

- WIROX	
• Universal	
- T-STAR <i>plus</i> .	26-36
- Ranura en cruz Z	37-46
- Cabeza reducida	45
- Con tapón	46
• Interiores	
- T-STAR <i>plus</i>	47-49
- SPAX-M para MDF	47
- SPAX tornillo de fijación	48
- SPAX para suelos de madera maciza.	49

- YELLOX	
• Universal	
-T-STAR <i>plus</i>	50-55
-SPAX- Encintado	55
-Ranura en cruz Z	56-67
-Cabeza reducida	65
-SPAX - Encintado.	66
• SPAX para listones de madera	67

- BRONCE	
• Universal	
-Ranura en cruz Z	68-71

- ACERO INOXIDABLE A2	
• Universal	
-T-STAR <i>plus</i>	72-75
- SPAX - Encintado	75
- Ranura en cruz Z.....	76-79
• SPAX para listones de madera	79

- ACERO INOXIDABLE A4	
• Construcciones de madera	
-T-STAR <i>plus</i>	80-81



CABEZA PLANA

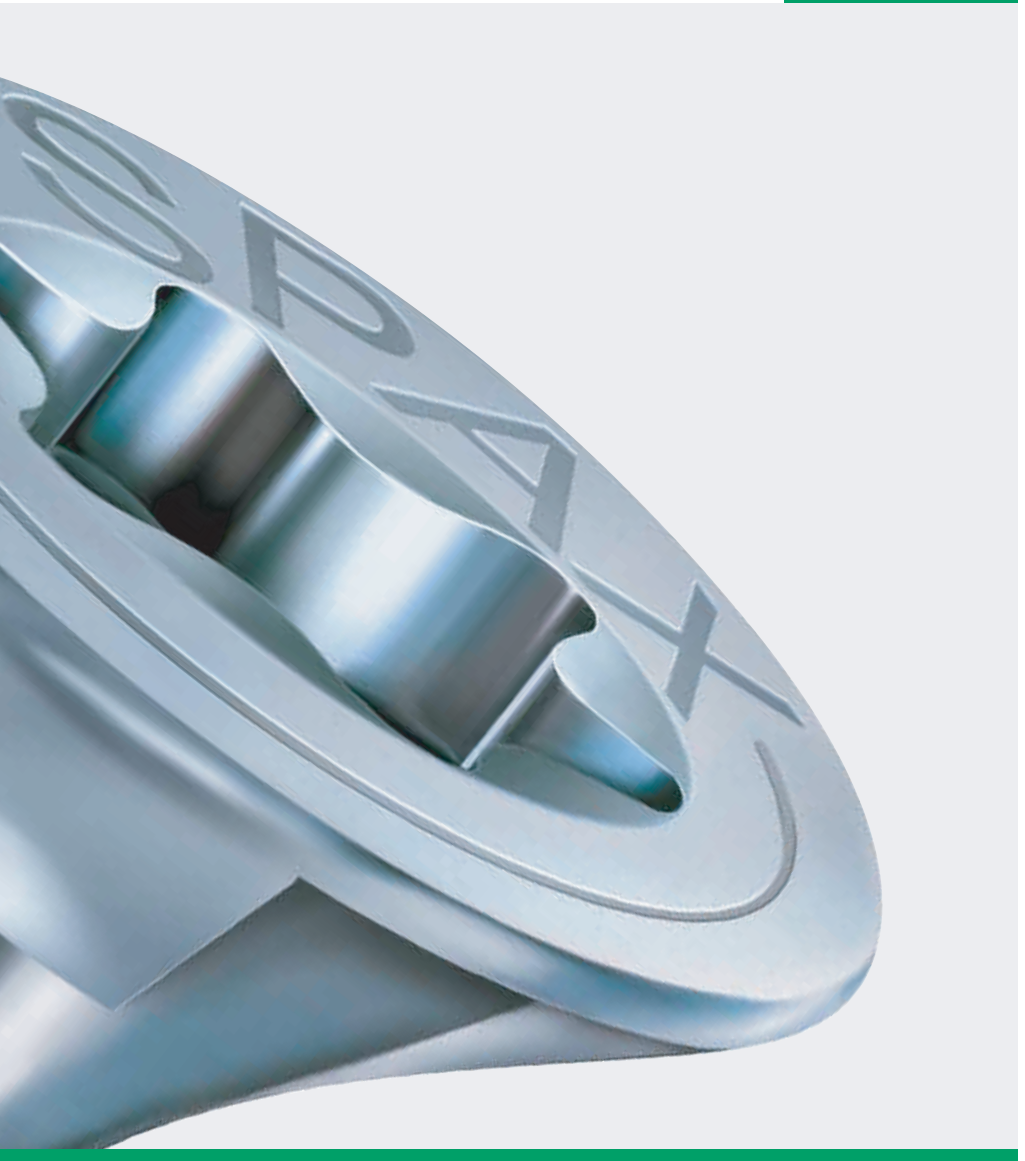

Los tornillos de cabeza plana se pueden avellanar completamente en la madera, proporcionando un óptimo resultado visual. Además, el riesgo de lesiones se reduce porque no hay ningún obstáculo que le haga tropezar.

El tornillo SPAX cabeza plana está disponible en acabado bronce, en WIROX o YELLOX y en acero inoxidable para necesidades de mayor exigencia frente a la corrosión.



Tornillo universal, cabeza plana,
T-STAR plus, rosca completa

4CUT, MULTI- Cabeza

Endurecido, revestimiento sintético

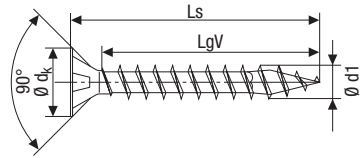

A9J



Rosca- Ø d1	Dimensiones [mm]			Unidades de venta			N° SPAX	Cód. EAN
	Longitud total Ls	Longitud rosca completa LgV	Tamaño Huella T	SPAX Box [uds]	Embalaje de cartón [uds]	Palé		
Embalaje estándar								
3.0* Ø dk = 6.0 mm	12	10	10	1,000	10,000	1,120,000	1191010300125	4003530105999
	16	14	10	1,000	10,000	1,120,000	1191010300165	4003530106002
	20	17	10	1,000	10,000	630,000	1191010300205	4003530106019
	25	21	10	1,000	10,000	630,000	1191010300255	4003530110276
	30	26	10	1,000	10,000	320,000	1191010300305	4003530106026
Embalaje pequeño								
3.0* Ø dk = 6.0 mm	12	10	10	200	2,000	470,000	1191010300123	4003530101083
	16	14	10	200	2,000	470,000	1191010300163	4003530101090
	20	17	10	200	2,000	260,000	1191010300203	4003530101113
	25	21	10	200	2,000	260,000	1191010300253	4003530110245
	30	26	10	200	2,000	260,000	1191010300303	4003530101359
Embalaje estándar								
3.5 Ø dk = 7.0 mm	15	11	20	1,000	10,000	630,000	1191010350155	4003530168574
	16	13	20	1,000	10,000	630,000	1191010350165	4003530148040
	20	16	20	1,000	10,000	630,000	1191010350205	4003530106033
	25	21	20	1,000	10,000	320,000	1191010350255	4003530111150
	30	25	20	1,000	10,000	320,000	1191010350305	4003530106101
	35	30	20	1,000	10,000	320,000	1191010350355	4003530106446
	40	35	20	1,000	10,000	280,000	1191010350405	4003530106453
45	40	20	1,000	10,000	280,000	1191010350455	4003530106460	
Embalaje pequeño								
3.5 Ø dk = 7.0 mm	16	13	20	200	2,000	260,000	1191010350163	4003530148743
	20	16	20	200	2,000	260,000	1191010350203	4003530101366
	25	21	20	200	2,000	260,000	1191010350253	4003530110252
	30	25	20	200	2,000	260,000	1191010350303	4003530101373
	35	30	20	200	2,000	224,000	1191010350353	4003530101571
	40	35	20	200	2,000	224,000	1191010350403	4003530101588
	45	40	20	200	2,000	126,000	1191010350453	4003530101663

*Diseño divergente.



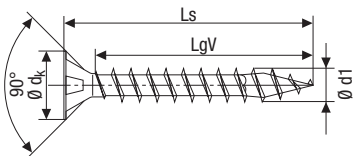

Tornillo universal, cabeza plana,
T-STAR plus, rosca completa

4CUT, MULTI- Cabeza

Endurecido, revestimiento sintético



A9J

Rosca- \varnothing d_1	Dimensiones [mm]			Unidades de venta			N° SPAX	Cód.EAN
	Longitud total L_s	Longitud rosca completa L_gV	Tamaño Huella T	SPAX Box [uds]	Embalaje de cartón [uds]	Palé		
Embalaje estándar								
4.0 $\varnothing d_k = 8.0$ mm	15	11	20	1,000	10,000	630,000	1191010400155	4003530157394
	16	13	20	1,000	10,000	630,000	1191010400165	4003530155482
	20	16	20	1,000	10,000	630,000	1191010400205	4003530148798
	25	21	20	1,000	10,000	320,000	1191010400255	4003530111174
	30	25	20	1,000	10,000	320,000	1191010400305	4003530107191
	35	30	20	1,000	10,000	280,000	1191010400355	4003530107825
	40	35	20	1,000	10,000	280,000	1191010400405	4003530107863
	45	40	20	500	5,000	160,000	1191010400455	4003530107887
	50	45	20	500	5,000	140,000	1191010400505	4003530107917
Embalaje pequeño								
4.0 $\varnothing d_k = 8.0$ mm	25	21	20	200	2,000	260,000	1191010400253	4003530110269
	30	25	20	200	2,000	224,000	1191010400303	4003530102219
	35	30	20	200	2,000	224,000	1191010400353	4003530102233
	40	35	20	200	2,000	126,000	1191010400403	4003530102240
	45	40	20	200	2,000	126,000	1191010400453	4003530102615
	50	45	20	200	2,000	126,000	1191010400503	4003530103377
Embalaje estándar								
4.5 $\varnothing d_k = 8.8$ mm	16	13	20	1,000	10,000	630,000	1191010450165	4003530178382
	20	15	20	1,000	10,000	320,000	1191010450205	4003530169847
	25	20	20	1,000	10,000	320,000	1191010450255	4003530169854
	30	25	20	1,000	10,000	280,000	1191010450305	4003530169861
	35	30	20	500	5,000	160,000	1191010450355	4003530107924
	40	34	20	500	5,000	160,000	1191010450405	4003530107931
	45	39	20	500	5,000	140,000	1191010450455	4003530108051
	50	44	20	500	5,000	140,000	1191010450505	4003530108068
	60	54	20	500	5,000	140,000	1191010450605	4003530108075
	70	59*	20	500	2,500	140,000	1191010450705	4003530108082
Embalaje pequeño								
4.5 $\varnothing d_k = 8.8$ mm	35	30	20	200	2,000	126,000	1191010450353	4003530103575
	40	34	20	200	2,000	126,000	1191010450403	4003530103667
	45	39	20	200	2,000	126,000	1191010450453	4003530103681
	50	44	20	200	2,000	64,000	1191010450503	4003530103698
	60	54	20	100	1,000	63,000	1191010450603	4003530103933
	70	59*	20	100	1,000	32,000	1191010450703	4003530104077

*Modelo divergente. Rosca casi hasta la cabeza.





Tornillo universal, cabeza plana,
T-STAR plus, rosca completa/parcial

4CUT, MULTI- Cabeza

Endurecido, revestimiento sintético

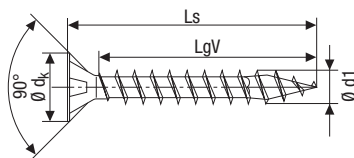

Rosca- Ø d1	Dimensiones [mm]			Unidades de venta			N° SPAX	Cód. EAN
	Longitud total Ls	Longitud rosca completa LgV	Tamaño Huella T	SPAX Box [uds]	Embalaje de cartón [uds]	Palé		
Embalaje estándar								
5.0 Ø dk = 9.7 mm	20	15	20	1,000	10,000	320,000	1191010500205	4003530169878
	25	20	20	1,000	10,000	320,000	1191010500255	4003530169885
	30	25	20	500	5,000	160,000	1191010500305	4003530169892
	35	30	20	500	5,000	160,000	1191010500355	4003530169908
	40	35	20	500	5,000	140,000	1191010500405	4003530109003
	45	39	20	500	5,000	140,000	1191010500455	4003530109447
	50	44	20	500	5,000	140,000	1191010500505	4003530109454
	60	54	20	500	2,500	140,000	1191010500605	4003530109553
70	61*	20	200	2,000	64,000	1191010500705	4003530109560	
80	61*	20	200	2,000	64,000	1191010500805	4003530109683	
Embalaje pequeño								
5.0 Ø dk = 9.7 mm	40	35	20	200	2,000	126,000	1191010500403	4003530105814
	45	39	20	200	2,000	126,000	1191010500453	4003530105869
	50	44	20	200	2,000	64,000	1191010500503	4003530105890
	60	54	20	100	1,000	63,000	1191010500603	4003530105906
	70	61*	20	100	1,000	32,000	1191010500703	4003530105913
	80	61*	20	100	1,000	32,000	1191010500803	4003530105920
Embalaje estándar								
6.0 Ø dk = 11.6 mm	50	43	30	200	2,000	64,000	1191010600505	4003530109690
	60	53	30	200	2,000	56,000	1191010600605	4003530109706
	70	61*	30	200	2,000	56,000	1191010600705	4003530109843
	80	61*	30	200	2,000	56,000	1191010600805	4003530110238
Embalaje pequeño								
6.0 Ø dk = 11.6 mm	50	43	30	100	1,000	32,000	1191010600503	4003530105937
	60	53	30	100	1,000	32,000	1191010600603	4003530105944
	70	61*	30	100	1,000	32,000	1191010600703	4003530105968
	80	61*	30	100	1,000	32,000	1191010600803	4003530105975

*Modelo divergente. Rosca casi hasta la cabeza.



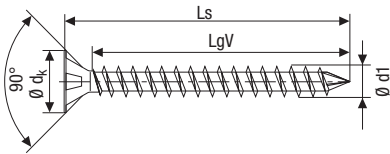

Tornillo construcción en madera, cabeza plana,
T-STAR *plus*, rosca completa

MULTI-Cabeza, punta CUT

Endurecido, revestimiento sintético



A9J

Rosca- Ø d1	Dimensiones [mm]			Unidad de venta			N° SPAX	Cód. EAN
	Longitud total Ls	Longitud rosca completa LgV	Tamaño Huella T	SPAX Box [uds]	Embalaje de cartón [uds]	Palé		
Embalaje estándar								
8.0 Ø dk = 15.1 mm	120		40	50	500	14,000	1201010801205	4003530257278
	140		40	50	500	14,000	1201010801405	4003530257285
	160		40	50	500	14,000	1201010801605	4003530245992
	180		40	50	500	14,000	1201010801805	4003530246005
	200		40	50	500	12,000	1201010802005	4003530246012
	220		40	50	500	12,000	1201010802205	4003530246029
	240		40	50	-	4,800	1201010802405	4003530246036
	260		40	50	-	4,800	1201010802605	4003530246043
	280		40	50	-	4,800	1201010802805	4003530246050
	300		40	50	-	4,800	1201010803005	4003530246067
	350		40	50	-	3,600	1201010803505	4003530246074
	400		40	50	-	3,600	1201010804005	4003530246081
	450		40	50	-	3,000	1201010804505	4003530246098
	500	Rosca	40	25	-	1,200	1201010805005	4003530246104
550	casi	40	25	-	1,200	1201010805505	4003530246111	
600	hasta la	40	25	-	1,200	1201010806005	4003530246128	
10.0 Ø dk = 18.6 mm	120	cabeza	50	50	500	12,000	1201011001205	4003530257469
	160		50	50	500	12,000	1201011001605	4003530252273
	200		50	50	500	12,000	1201011002005	4003530246135
	220		50	50	500	12,000	1201011002205	4003530246142
	240		50	50	-	4,800	1201011002405	4003530246159
	260		50	50	-	4,800	1201011002605	4003530246166
	280		50	50	-	4,800	1201011002805	4003530246173
	300		50	50	-	4,800	1201011003005	4003530246180
	350		50	50	-	3,600	1201011003505	4003530246197
	400		50	50	-	3,600	1201011004005	4003530246203
	450		50	50	-	3,000	1201011004505	4003530246210
	500		50	25	-	1,200	1201011005005	4003530246227
	550		50	25	-	1,200	1201011005505	4003530246234
	600		50	25	-	1,200	1201011006005	4003530246241
700		50	25	-	800	1201011007005	4003530257476	
800		50	25	-	800	1201011008005	4003530246258	



NUEVO





Tornillo para construcciones de madera, cabeza plana,
T-STAR *plus*, rosca completa

Nervios fresadores, punta *CUT*

Endurecido, revestimiento sintético

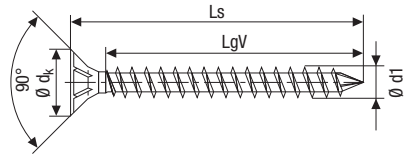

WIROX

A9J



Rosca- Ø	Dimensiones [mm]			Tamaño Huella	Unidades de venta			N° SPAX	Cód. EAN
	Longitud total	Longitud rosca completa			SPAX Box [uds]	Embalaje de cartón [uds]	Palé		
d1	Ls	LgV	T						
Embalaje estándar									
12.0 Ø dk = 18.6 mm	200		50	25	250	6,000	1201011202005	4003530246265	
	240		50	25	–	2,400	1201011202405	4003530246272	
	280		50	25	–	2,400	1201011202805	4003530246289	
	300	Rosca	50	25	–	2,400	1201011203005	4003530246296	
	350	casi	50	25	–	1,800	1201011203505	4003530246302	
	400	hasta la	50	25	–	1,800	1201011204005	4003530246319	
	450	cabeza	50	25	–	1,500	1201011204505	4003530246326	
	500		50	25	–	1,500	1201011205005	4003530246333	
	550		50	20	–	960	1201011205505	4003530246340	
600*		50	20	–	960	1201011206005	4003530246357		

*Diferente acabado: P3J



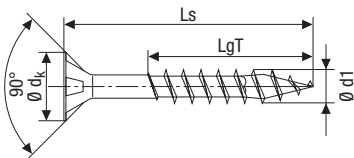

Tornillo universal, cabeza plana,
T-STAR plus, rosca parcial

4CUT, MULTI- Cabeza

Endurecido, revestimiento sintético



A9J

Rosca- \varnothing	Dimensiones [mm]			Unidad de venta			N° SPAX	Cód. EAN
	Longitud total	Longitud rosca parcial	Tamaño Huella	SPAX Box [uds]	Embalaje de cartón [uds]	Palé		
d1	Ls	LgT	T					
Embalaje estándar								
3.0* $\varnothing d_k =$ 6.0 mm	30	18	10	1,000	10,000	320,000	0191010300305	4003530098093
	35	23	10	1,000	10,000	320,000	0191010300355	4003530098109
	40	23	10	1,000	10,000	280,000	0191010300405	4003530098116
3.5 $\varnothing d_k =$ 7.0 mm	30	18	20	1,000	10,000	320,000	0191010350305	4003530096778
	35	23	20	1,000	10,000	320,000	0191010350355	4003530096785
	40	23	20	1,000	10,000	280,000	0191010350405	4003530096792
	45	30	20	1,000	10,000	280,000	0191010350455	4003530098192
	50	32	20	500	5,000	160,000	0191010350505	4003530098208
Embalaje pequeño								
3.5 $\varnothing d_k =$ 7.0 mm	30	18	20	200	2,000	260,000	0191010350303	4003530164279
	35	23	20	200	2,000	224,000	0191010350353	4003530164132
	40	23	20	200	2,000	224,000	0191010350403	4003530164064
	45	30	20	200	2,000	126,000	0191010350453	4003530164286
	50	32	20	200	2,000	126,000	0191010350503	4003530164071
Embalaje estándar								
4.0 $\varnothing d_k =$ 8.0 mm	30	18	20	1,000	10,000	320,000	0191010400305	4003530096808
	35	23	20	1,000	10,000	280,000	0191010400355	4003530096815
	40	23	20	1,000	10,000	280,000	0191010400405	4003530149337
	45	30	20	500	5,000	160,000	0191010400455	4003530149474
	50	32	20	500	5,000	140,000	0191010400505	4003530149092
	60	35	20	500	5,000	140,000	0191010400605	4003530149443
	70	37	20	500	2,500	140,000	0191010400705	4003530155178
	80	37	20	200	2,000	64,000	0191010400805	4003530165702
Embalaje pequeño								
4.0 $\varnothing d_k =$ 8.0 mm	30	18	20	200	2,000	224,000	0191010400303	4003530164248
	35	23	20	200	2,000	224,000	0191010400353	4003530164255
	40	23	20	200	2,000	126,000	0191010400403	4003530164194
	45	30	20	200	2,000	126,000	0191010400453	4003530164347
	50	32	20	200	2,000	126,000	0191010400503	4003530164187
	60	35	20	100	1,000	63,000	0191010400603	4003530164354
	70	37	20	100	1,000	32,000	0191010400703	4003530165696

*Modelo divergente.





Tornillo universal, cabeza plana,
T-STAR plus, rosca parcial

4CUT, MULTI-Cabeza

Endurecido, revestimiento sintético

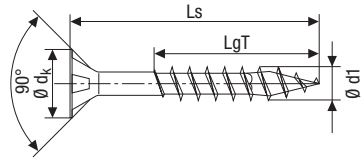

Rosca- Ø	Dimensiones [mm]			Unidad de venta			Nº SPAX	Cód. EAN
	Longitud total	Longitud rosca parcial	Tamaño Huella	SPAX Box [uds]	Embalaje de cartón [uds]	Palé		
d1	Ls	LgT	T					
Embalaje estándar								
4.5 Ø dk = 8.8 mm	30	17	20	1,000	10,000	280,000	0191010450305	4003530147814
	35	25	20	500	5,000	160,000	0191010450355	4003530096860
	40	25	20	500	5,000	160,000	0191010450405	4003530155338
	45	30	20	500	5,000	140,000	0191010450455	4003530154157
	50	32	20	500	5,000	140,000	0191010450505	4003530154171
	60	37	20	500	5,000	140,000	0191010450605	4003530149245
	70	42	20	500	2,500	140,000	0191010450705	4003530154447
	80	47	20	200	2,000	64,000	0191010450805	4003530156304
Embalaje pequeño								
4.5 Ø dk = 8.8 mm	30	17	20	200	2,000	224,000	0191010450303	4003530164392
	35	25	20	200	2,000	126,000	0191010450353	4003530164422
	40	25	20	200	2,000	126,000	0191010450403	4003530164309
	45	30	20	200	2,000	126,000	0191010450453	4003530164385
	50	32	20	200	2,000	64,000	0191010450503	4003530164262
	60	37	20	100	1,000	63,000	0191010450603	4003530164316
	70	42	20	100	1,000	32,000	0191010450703	4003530164323
	80	47	20	100	1,000	32,000	0191010450803	4003530164507



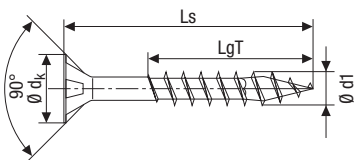

Tornillo universal, cabeza plana,
T-STAR plus, rosca parcial

4CUT, MULTI-Cabeza

Endurecido, revestimiento sintético



A9J

Rosca- \varnothing d_1	Dimensiones [mm]			Unidad de venta			N° SPAX	Cód. EAN
	Longitud total L_s	Longitud rosca parcial $L_g T$	Tamaño Huella T	SPAX Box [uds]	Embalaje de cartón [uds]	Palé		
Embalaje estándar								
5.0 $\varnothing d_k = 9.7$ mm	30	17	20	500	5,000	160,000	0191010500305	4003530098390
	35	25	20	500	5,000	160,000	0191010500355	4003530098406
	40	27	20	500	5,000	140,000	0191010500405	4003530098413
	45	30	20	500	5,000	140,000	0191010500455	4003530098420
	50	32	20	500	5,000	140,000	0191010500505	4003530154294
	55	37	20	500	5,000	140,000	0191010500555	4003530098444
	60	37	20	500	2,500	140,000	0191010500605	4003530149634
	70	41	20	200	2,000	64,000	0191010500705	4003530154317
	80	46	20	200	2,000	64,000	0191010500805	4003530154300
	90	61	20	200	2,000	64,000	0191010500905	4003530154324
100	61	20	200	2,000	64,000	0191010501005	4003530155116	
120	69	20	200	2,000	56,000	0191010501205	4003530156113	
Embalaje pequeño								
5.0 $\varnothing d_k = 9.7$ mm	30	17	20	200	2,000	224,000	0191010500303	4003530164514
	40	27	20	200	2,000	126,000	0191010500403	4003530164576
	50	32	20	200	2,000	64,000	0191010500503	4003530164460
	60	37	20	100	1,000	63,000	0191010500603	4003530164477
	70	41	20	100	1,000	32,000	0191010500703	4003530164521
	80	46	20	100	1,000	32,000	0191010500803	4003530164484
	90	61	20	100	1,000	32,000	0191010500903	4003530164606
	100	61	20	100	1,000	32,000	0191010501003	4003530164767





Tornillo universal, cabeza plana,
T-STAR plus, rosca parcial

4CUT, MULTI-Cabeza

Endurecido, revestimiento sintético

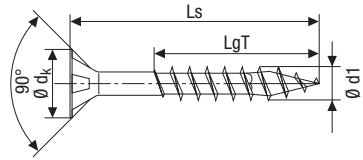

Rosca- Ø d1	Dimensiones [mm]			Unidad de venta			N° SPAX	Cód. EAN
	Longitud total Ls	Longitud rosca parcial LgT	Tamaño Huella T	SPAX Box [uds]	Embalaje de cartón [uds]	Palé		
Embalaje estándar								
6.0 Ø dk = 11.6 mm	40	24	30	500	2,500	140,000	0191010600405	4003530111488
	50	32	30	200	2,000	64,000	0191010600505	4003530096945
	60	37	30	200	2,000	56,000	0191010600605	4003530155161
	70	41	30	200	2,000	56,000	0191010600705	4003530155567
	80	46	30	200	2,000	56,000	0191010600805	4003530149481
	90	61	30	200	1,000	56,000	0191010600905	4003530155291
	100	61	30	100	1,000	32,000	0191010601005	4003530155307
	110	68	30	100	1,000	32,000	0191010601105	4003530157677
	120	68	30	100	1,000	28,000	0191010601205	4003530155321
	130	68	30	100	1,000	28,000	0191010601305	4003530157622
	140	68	30	100	1,000	28,000	0191010601405	4003530155314
	150	68	30	100	1,000	28,000	0191010601505	4003530157646
	160	65	30	100	1,000	28,000	0191010601605	4003530155819
	180	65	30	100	1,000	28,000	0191010601805	4003530156205
	200	65	30	100	1,000	24,000	0191010602005	4003530156090
	220	65	30	100	1,000	24,000	0191010602205	4003530098666
	240	65	30	100	1,000	24,000	0191010602405	4003530098673
260	65	30	100	-	9,600	0191010602605	4003530098680	
280	65	30	100	-	9,600	0191010602805	4003530098697	
300	65	30	100	-	9,600	0191010603005	4003530098703	
Embalaje pequeño								
6.0 Ø dk = 11.6 mm	50	32	30	100	1,000	32,000	0191010600503	4003530164569
	60	37	30	100	1,000	32,000	0191010600603	4003530164101
	70	41	30	100	1,000	32,000	0191010600703	4003530164293
	80	46	30	100	1,000	32,000	0191010600803	4003530164118
	90	61	30	100	1,000	32,000	0191010600903	4003530164491



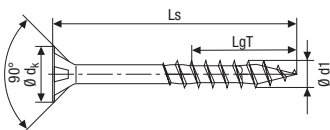

Tornillo para construcción en madera, cabeza plana,
T-STAR plus, rosca parcial

4CUT, MULTI-Cabeza

Endurecido, revestimiento sintético



A9J

Rosca- \varnothing d1	Dimensiones [mm]			Unidad de venta			N° SPAX	Cód. EAN
	Longitud total Ls	Longitud rosca parcial LgT	Tamaño Huella T	SPAX Box [uds]	Embalaje de cartón [uds]	Palé		
Embalaje estándar								
8.0 $\varnothing d_k = 15.1$ mm	80	47	40	50	500	14,000	0191010800805	4003530243837
	100	57	40	50	500	14,000	0191010801005	4003530244100
	120	70	40	50	500	14,000	0191010801205	4003530244117
	140	80	40	50	500	14,000	0191010801405	4003530244124
	160	80	40	50	500	14,000	0191010801605	4003530244131
	180	80	40	50	500	14,000	0191010801805	4003530244148
	200	80	40	50	500	12,000	0191010802005	4003530244155
	220	80	40	50	500	12,000	0191010802205	4003530244162
	240	80	40	50	-	4,800	0191010802405	4003530244179
	260	80	40	50	-	4,800	0191010802605	4003530244186
	280	80	40	50	-	4,800	0191010802805	4003530244193
	300	80	40	50	-	4,800	0191010803005	4003530244209
	320	80	40	50	-	3,600	0191010803205	4003530244216
	340	80	40	50	-	3,600	0191010803405	4003530244223
	360	80	40	50	-	3,600	0191010803605	4003530244230
	380	80	40	50	-	3,600	0191010803805	4003530244247
400	80	40	50	-	3,600	0191010804005	4003530244254	
450	80	40	50	-	3,000	0191010804505	4003530244261	
10.0 $\varnothing d_k = 18.6$ mm	80	50	50	50	500	14,000	0191011000805	4003530244278
	100	60	50	50	500	14,000	0191011001005	4003530244285
	120	80	50	50	500	14,000	0191011001205	4003530244292
	140	80	50	50	500	14,000	0191011001405	4003530244308
	160	80	50	50	500	14,000	0191011001605	4003530244315
	180	80	50	50	500	14,000	0191011001805	4003530244322
	200	80	50	50	500	12,000	0191011002005	4003530244339
	220	80	50	50	500	12,000	0191011002205	4003530244346
	240	80	50	50	-	4,800	0191011002405	4003530244353
	260	80	50	50	-	4,800	0191011002605	4003530244360
	280	80	50	50	-	4,800	0191011002805	4003530245329
	300	80	50	50	-	4,800	0191011003005	4003530245336
	320	80	50	50	-	3,600	0191011003205	4003530245343
	340	80	50	50	-	3,600	0191011003405	4003530245350
	360	80	50	50	-	3,600	0191011003605	4003530245367
	380	80	50	50	-	3,600	0191011003805	4003530245374
400	80	50	50	-	3,600	0191011004005	4003530245381	
450	80	50	50	-	3,000	0191011004505	4003530245398	



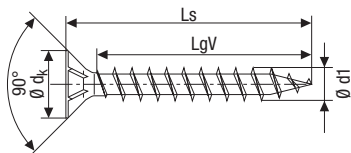

Tornillo universal, cabeza plana,
Ranura en cruz Z, rosca completa

Endurecido, revestimiento sintético



A9J

Rosca- Ø d1	Dimensiones [mm]			Unidad de venta			N° SPAX	Cód. EAN
	Longitud total Ls	Longitud rosca completa LgV	Tamaño Huella Z	SPAX Box [uds]	Embalaje de cartón [uds]	Palé		
Embalaje estándar								
2.5* Ø dk = 5.1 mm	10	8	1	1.000	10,000	1,120,000	1081010250105	4003530003752
	12	10	1	1.000	10,000	1,120,000	1081010250125	4003530003769
	16	14	1	1.000	10,000	1,120,000	1081010250165	4003530003776
	20	17	1	1.000	10,000	1,120,000	1081010250205	4003530003783
	25	22	1	1.000	10,000	630,000	1081010250255	4003530003790
3.0* Ø dk = 6.0 mm	10	7	1	1.000	10,000	1,120,000	1081010300105	4003530003806
	12	10	1	1.000	10,000	1,120,000	1081010300125	4003530003813
	13	10	1	1.000	10,000	1,120,000	1081010300135	4003530009396
	15	12	1	1.000	10,000	1,120,000	1081010300155	4003530003820
	16	14	1	1.000	10,000	1,120,000	1081010300165	4003530003837
	17	14	1	1.000	10,000	1,120,000	1081010300175	4003530009402
	20	17	1	1.000	10,000	630,000	1081010300205	4003530003844
	25	21	1	1.000	10,000	630,000	1081010300255	4003530003851
	30	26	1	1.000	10,000	320,000	1081010300305	4003530003868
	35	31	1	1.000	10,000	320,000	1081010300355	4003530003875
	40	36	1	1.000	10,000	280,000	1081010300405	4003530003882
45	36*	1	1.000	10,000	280,000	1081010300455	4003530003899	
Embalaje pequeño								
3.0* Ø dk = 6.0 mm	12	10	1	200	2,000	470,000	1081010300123	4003530006012
	16	14	1	200	2,000	470,000	1081010300163	4003530006029
	20	17	1	200	2,000	260,000	1081010300203	4003530006036
	25	21	1	200	2,000	260,000	1081010300253	4003530006043
	30	26	1	200	2,000	260,000	1081010300303	4003530006050
	35	31	1	200	2,000	260,000	1081010300353	4003530006067
	40	36	1	200	2,000	224,000	1081010300403	4003530006074

*Modelo divergente.





Tornillo universal, cabeza plana,

Ranura en cruz Z, rosca completa

4CUT, MULTI-Cabeza

Endurecido, revestimiento sintético

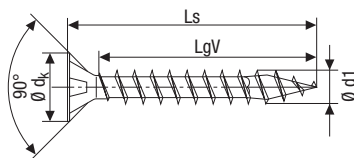

WIROX

A9J



Rosca- Ø d1	Dimensiones [mm]			Unidad de venta			N° SPAX	Cód. EAN
	Longitud total Ls	Longitud rosca completa LgV	Tamaño Huella Z	SPAX Box [uds]	Embalaje de cartón [uds]	Palé		
Embalaje estándar								
3.5 Ø dk = 7.0 mm	12	9	2	1,000	10,000	1,120,000	1081010350125	4003530003905
	13	9	2	1,000	10,000	1,120,000	1081010350135	4003530009419
	15	11	2	1,000	10,000	630,000	1081010350155	4003530003912
	16	13	2	1,000	10,000	630,000	1081010350165	4003530003929
	17	13	2	1,000	10,000	630,000	1081010350175	4003530009426
	20	16	2	1,000	10,000	630,000	1081010350205	4003530003943
	25	21	2	1,000	10,000	320,000	1081010350255	4003530003950
	30	25	2	1,000	10,000	320,000	1081010350305	4003530003967
	35	30	2	1,000	10,000	320,000	1081010350355	4003530003974
	40	35	2	1,000	10,000	280,000	1081010350405	4003530003981
45	40	2	1,000	10,000	280,000	1081010350455	4003530003998	
50	40*	2	500	5,000	160,000	1081010350505	4003530004001	
Embalaje pequeño								
3.5 Ø dk = 7.0 mm	12	9	2	200	2,000	470,000	1081010350123	4003530006081
	16	13	2	200	2,000	260,000	1081010350163	4003530006098
	20	16	2	200	2,000	260,000	1081010350203	4003530006104
	25	21	2	200	2,000	260,000	1081010350253	4003530006111
	30	25	2	200	2,000	260,000	1081010350303	4003530006128
	35	30	2	200	2,000	224,000	1081010350353	4003530006135
	40	35	2	200	2,000	224,000	1081010350403	4003530006142
	45	40	2	200	2,000	126,000	1081010350453	4003530006159
	50	40*	2	200	2,000	126,000	1081010350503	4003530006166

*Modelo divergente. Rosca casi hasta la cabeza.



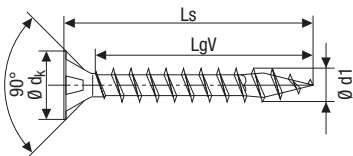

Tornillo universal, cabeza plana,
Ranura en cruz Z, rosca completa

4CUT, MULTI-Cabeza

Endurecido, revestimiento sintético



A9J

Rosca- Ø d1	Dimensiones [mm]			Unidad de venta			N° SPAX	Cód. EAN
	Longitud total Ls	Longitud rosca completa LgV	Tamaño Huella Z	SPAX Box [uds]	Embalaje de cartón [uds]	Palé		
Embalaje estándar								
4.0 Ø dk = 8.0 mm	12	9	2	1,000	10,000	630,000	1081010400125	4003530004018
	15	11	2	1,000	10,000	630,000	1081010400155	4003530009433
	16	13	2	1,000	10,000	630,000	1081010400165	4003530004025
	17	13	2	1,000	10,000	630,000	1081010400175	4003530009440
	20	16	2	1,000	10,000	630,000	1081010400205	4003530004032
	25	21	2	1,000	10,000	320,000	1081010400255	4003530004049
	30	25	2	1,000	10,000	320,000	1081010400305	4003530004056
	35	30	2	1,000	10,000	280,000	1081010400355	4003530004063
	40	35	2	1,000	10,000	280,000	1081010400405	4003530004070
	45	40	2	500	5,000	160,000	1081010400455	4003530004087
	50	45	2	500	5,000	140,000	1081010400505	4003530004094
	55	50	2	500	5,000	140,000	1081010400555	4003530004100
	60	50*	2	500	5,000	140,000	1081010400605	4003530004117
70	50*	2	500	2,500	140,000	1081010400705	4003530004124	
80	50*	2	200	2,000	64,000	1081010400805	4003530039997	
Embalaje pequeño								
4.0 Ø dk = 8.0 mm	12	9	2	200	2,000	260,000	1081010400123	4003530006173
	16	13	2	200	2,000	260,000	1081010400163	4003530006180
	20	16	2	200	2,000	260,000	1081010400203	4003530006197
	25	21	2	200	2,000	260,000	1081010400253	4003530006203
	30	25	2	200	2,000	224,000	1081010400303	4003530006210
	35	30	2	200	2,000	224,000	1081010400353	4003530006227
	40	35	2	200	2,000	126,000	1081010400403	4003530006234
	45	40	2	200	2,000	126,000	1081010400453	4003530006241
	50	45	2	200	2,000	126,000	1081010400503	4003530006258
	60	50*	2	100	1,000	63,000	1081010400603	4003530006265
70	50*	2	100	1,000	32,000	1081010400703	4003530006272	

*Modelo divergente. Rosca casi hasta la cabeza.





Tornillo universal, cabeza plana,

Ranura en cruz Z, rosca completa

4CUT, MULTI-Cabeza

Endurecido, revestimiento sintético

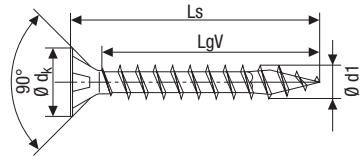

WIROX

A9J



Rosca- Ø d1	Dimensiones [mm]			Unidad de venta			N° SPAX	Cód. EAN
	Longitud total Ls	Longitud rosca completa LgV	Tamaño Huella Z	SPAX Box [uds]	Embalaje de cartón [uds]	Palé		
Embalaje estándar								
4.5 Ø dk = 8.8 mm	16	13	2	1,000	10,000	630,000	1081010450165	4003530004131
	20	15	2	1,000	10,000	320,000	1081010450205	4003530004148
	25	20	2	1,000	10,000	320,000	1081010450255	4003530004155
	30	25	2	1,000	10,000	280,000	1081010450305	4003530004162
	35	30	2	500	5,000	160,000	1081010450355	4003530004179
	40	34	2	500	5,000	160,000	1081010450405	4003530004186
	45	39	2	500	5,000	140,000	1081010450455	4003530004193
	50	44	2	500	5,000	140,000	1081010450505	4003530004209
	55	49	2	500	5,000	140,000	1081010450555	4003530004216
	60	54	2	500	5,000	140,000	1081010450605	4003530004223
70	59*	2	500	2,500	140,000	1081010450705	4003530004230	
80	59*	2	200	2,000	64,000	1081010450805	4003530004247	
Embalaje pequeño								
4.5 Ø dk = 8.8 mm	16	13	2	200	2,000	260,000	1081010450163	4003530006289
	20	15	2	200	2,000	260,000	1081010450203	4003530006296
	25	20	2	200	2,000	224,000	1081010450253	4003530006302
	30	25	2	200	2,000	224,000	1081010450303	4003530006319
	35	30	2	200	2,000	126,000	1081010450353	4003530006326
	40	34	2	200	2,000	126,000	1081010450403	4003530006333
	45	39	2	200	2,000	126,000	1081010450453	4003530006340
	50	44	2	200	2,000	64,000	1081010450503	4003530006357
	60	54	2	100	1,000	63,000	1081010450603	4003530006364
	70	59*	2	100	1,000	32,000	1081010450703	4003530006371
80	59*	2	100	1,000	32,000	1081010450803	4003530006388	

*Modelo divergente. Rosca casi hasta la cabeza.



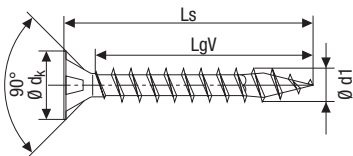

Tornillo universal, cabeza plana,
Ranura en cruz Z, rosca completa

4CUT, MULTI-Cabeza

Endurecido, revestimiento sintético



A9J

Rosca- \varnothing d1	Dimensiones [mm]			Unidad de venta			N° SPAX	Cód. EAN
	Longitud total Ls	Longitud rosca completa LgV	Tamaño Huella Z	SPAX Box [uds]	Embalaje de cartón [uds]	Palé		
Embalaje estándar								
5.0 $\varnothing d_k = 9.7$ mm	16	12	2	1,000	10,000	320,000	1081010500165	4003530004254
	20	15	2	1,000	10,000	320,000	1081010500205	4003530004261
	25	20	2	1,000	10,000	320,000	1081010500255	4003530004278
	30	25	2	500	5,000	160,000	1081010500305	4003530004285
	35	30	2	500	5,000	160,000	1081010500355	4003530004292
	40	35	2	500	5,000	140,000	1081010500405	4003530004308
	45	39	2	500	5,000	140,000	1081010500455	4003530004315
	50	44	2	500	5,000	140,000	1081010500505	4003530004322
	55	49	2	500	5,000	140,000	1081010500555	4003530004339
	60	54	2	500	2,500	140,000	1081010500605	4003530004346
70	61*	2	200	2,000	64,000	1081010500705	4003530004360	
80	61*	2	200	2,000	64,000	1081010500805	4003530004377	
Embalaje pequeño								
5.0 $\varnothing d_k = 9.7$ mm	20	15	2	200	2,000	260,000	1081010500203	4003530006401
	25	20	2	200	2,000	224,000	1081010500253	4003530006418
	30	25	2	200	2,000	224,000	1081010500303	4003530006425
	35	30	2	200	2,000	126,000	1081010500353	4003530006432
	40	35	2	200	2,000	126,000	1081010500403	4003530006449
	45	39	2	200	2,000	126,000	1081010500453	4003530006456
	50	44	2	200	2,000	64,000	1081010500503	4003530006463
	60	54	2	100	1,000	63,000	1081010500603	4003530006487
	70	61*	2	100	1,000	32,000	1081010500703	4003530006494
	80	61*	2	100	1,000	32,000	1081010500803	4003530006500

*Modelo divergente. Rosca casi hasta la cabeza.





Tornillo universal, cabeza plana,

Ranura en cruz Z, rosca completa

4CUT, MULTI-Cabeza

Endurecido, revestimiento sintético

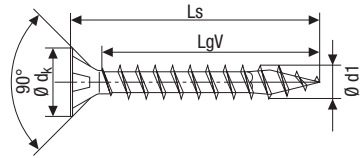

WIROX

A9J



Rosca- Ø	Dimensiones [mm]			Unidad de venta			N° SPAX	Cód. EAN
	Longitud total	Longitud rosca completa	Tamaño Huella	SPAX Box [uds]	Embalaje de cartón [uds]	Palé		
d1	Ls	LgV	Z					
Embalaje estándar								
6.0 Ø dk = 11.6 mm	30	24	3	500	5,000	160,000	1081010600305	4003530004421
	35	29	3	500	5,000	140,000	1081010600355	4003530004438
	40	34	3	500	2,500	140,000	1081010600405	4003530004445
	45	38	3	500	2,500	140,000	1081010600455	4003530004452
	50	43	3	200	2,000	64,000	1081010600505	4003530004469
	60	53	3	200	2,000	56,000	1081010600605	4003530004483
	70	61*	3	200	2,000	56,000	1081010600705	4003530004490
80	61*	3	200	2,000	56,000	1081010600805	4003530004506	
Embalaje pequeño								
6.0 Ø dk = 11.6 mm	40	34	3	200	2,000	64,000	1081010600403	4003530006531
	50	43	3	100	1,000	32,000	1081010600503	4003530012129
	60	53	3	100	1,000	32,000	1081010600603	4003530006562
	70	61*	3	100	1,000	32,000	1081010600703	4003530006579
	80	61*	3	100	1,000	32,000	1081010600803	4003530006586

*Modelo divergente. Rosca casi hasta la cabeza.



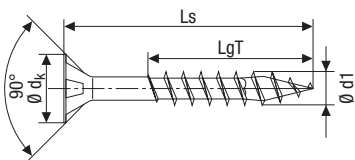

Tornillo universal, cabeza plana,

Ranura en cruz Z, rosca parcial

4CUT, MULTI-Cabeza

Endurecido, revestimiento sintético



A9J

Rosca- Ø d1	Dimensiones [mm]			Unidad de venta			N° SPAX	Cód. EAN
	Longitud total Ls	Longitud rosca parcial LgT	Tamaño Huella Z	SPAX Box [uds]	Embalaje de cartón [uds]	Palé		
Embalaje estándar								
3.5 Ø dk = 7.0 mm	30	18	2	1,000	10,000	320.000	0291010350305	4003530009662
	35	23	2	1,000	10,000	320.000	0291010350355	4003530009679
	40	23	2	1,000	10,000	280.000	0291010350405	4003530009686
	45	30	2	1,000	10,000	280.000	0291010350455	4003530106354
	50	32	2	500	5,000	280.000	0291010350505	4003530106361
4.0 Ø dk = 8.0 mm	30	18	2	1,000	10,000	320.000	0291010400305	4003530009693
	35	23	2	1,000	10,000	280.000	0291010400355	4003530009709
	40	23	2	1,000	10,000	280.000	0291010400405	4003530009723
	45	30	2	500	5,000	160.000	0291010400455	4003530009716
	50	32	2	500	5,000	140.000	0291010400505	4003530009730
	55	35	2	500	5,000	140.000	0291010400555	4003530039706
4.5 Ø dk = 8.8 mm	60	35	2	500	5,000	140.000	0291010400605	4003530009747
	35	25	2	500	5,000	160.000	0291010450355	4003530009761
	40	25	2	500	5,000	160.000	0291010450405	4003530009778
	45	30	2	500	5,000	140.000	0291010450455	4003530009785
	50	32	2	500	5,000	140.000	0291010450505	4003530009792
	55	37	2	500	5,000	140.000	0291010450555	4003530009808
	60	37	2	500	5,000	140.000	0291010450605	4003530009815
	70	42	2	500	2,500	140.000	0291010450705	4003530009822





Tornillo universal, cabeza plana,

Ranura en cruz Z, rosca parcial

4CUT, MULTI-Cabeza

Endurecido, revestimiento sintético

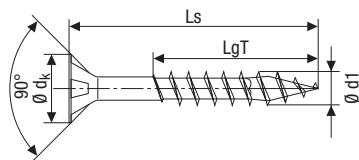

Rosca- Ø	Dimensiones [mm]			Tamaño Huella Z	Unidad de venta			N° SPAX	Cód. EAN
	Longitud total Ls	Longitud rosca parcial LgT			SPAX Box [uds]	Embalaje de cartón [uds]	Palé		
d1	Ls	LgT		Z					
Embalaje estándar									
5.0 Ø dk = 9.7 mm	40	27	2	500	5,000	140,000	0291010500405	4003530009846	
	45	30	2	500	5,000	140,000	0291010500455	4003530009853	
	50	32	2	500	5,000	140,000	0291010500505	4003530009860	
	55	37	2	500	5,000	140,000	0291010500555	4003530039737	
	60	37	2	500	2,500	140,000	0291010500605	4003530009877	
	65	41	2	200	2,000	64,000	0291010500655	4003530039751	
	70	41	2	200	2,000	64,000	0291010500705	4003530009884	
	80	46	2	200	2,000	64,000	0291010500805	4003530009891	
	90	61	2	200	2,000	64,000	1081010500905	4003530004384	
	100	61	2	200	2,000	64,000	1081010501005	4003530004391	
	110	69	2	200	2,000	64,000	1081010501105	4003530004407	
120	69	2	200	2,000	56,000	1081010501205	4003530004414		
Embalaje pequeño									
5.0 Ø dk = 9.7 mm	90	61	2	100	1,000	32,000	1081010500903	4003530006517	
	100	61	2	100	1,000	32,000	1081010501003	4003530006524	
Embalaje estándar									
6.0 Ø dk = 11.6 mm	60	37	3	200	2,000	56,000	0291010600605	4003530009938	
	70	41	3	200	2,000	56,000	0291010600705	4003530009945	
	80	46	3	200	2,000	56,000	0291010600805	4003530009952	
	90	61	3	200	1,000	56,000	1081010600905	4003530004513	
	100	61	3	100	1,000	32,000	1081010601005	4003530004520	
	120	68	3	100	1,000	28,000	1081010601205	4003530004544	
	140	68	3	100	1,000	28,000	1081010601405	4003530004568	
	160	65	3	100	1,000	28,000	1081010601605	4003530004582	
Embalaje pequeño									
6.0 Ø dk = 11.6 mm	90	61	3	100	1,000	32,000	1081010600903	4003530006593	



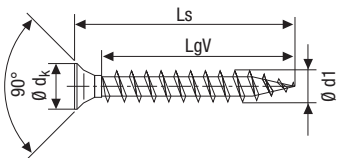

Tornillo universal, cabeza plana,

Ranura en cruz, rosca completa

Cabeza reducida (Ø 5 mm)

Endurecido, revestimiento sintético



A9J

Rosca- Ø	Dimensiones [mm]			Tamaño Huella Z	Unidad de venta			Nº SPAX	Cód. EAN
	Longitud total Ls	Longitud rosca completa LgV			SPAX Box [uds]	Embalaje de cartón [uds]	Palé		
d1	Ls	LgV	Z						
Emabalaje estándar									
3.0	10	7	1	1,000	10,000	1,120,000	0321010300105	4003530106545	
Ø dk =	12	10	1	1,000	10,000	1,120,000	0321010300125	4003530017582	
5.1 mm	15	12	1	1,000	10,000	1,120,000	0321010300155	4003530017605	





Tornillo universal, cabeza plana,

Ranura en cruz Z, rosca completa

Con taladro ($\varnothing 2.5 \text{ mm}$)

Endurecido, revestimiento sintético

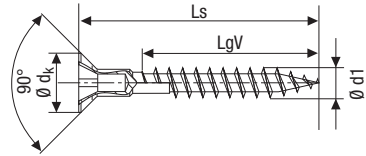

WIROX

A9J



Rosca- \varnothing	Dimensiones [mm]			Unidad de venta			N° SPAX	Cód. EAN
	Longitud total	Longitud rosca completa	Tamaño Huella	SPAX Box [uds]	Embalaje de cartón [uds]	Palé		
d1	Ls	LgV	Z					
Embalaje estándar								
4.5 $\varnothing dk = 8.8 \text{ mm}$	20	11	2	1,000	10,000	320,000	0271010450205	4003530017094
	25	15	2	1,000	10,000	320,000	0271010450255	4003530017100
	30	20	2	1,000	10,000	280,000	0271010450305	4003530017117
	35	25	2	500	5,000	160,000	0271010450355	4003530017124
	40	30	2	500	5,000	160,000	0271010450405	4003530017131
	45	34	2	500	5,000	140,000	0271010450455	4003530017148
	50	39	2	500	5,000	140,000	0271010450505	4003530017155
	55	44	2	500	5,000	140,000	0271010450555	4003530017162
	60	49	2	500	5,000	140,000	0271010450605	4003530017179
	70	59	2	500	2,500	140,000	0271010450705	4003530017186
5.0 $\varnothing dk = 9.7 \text{ mm}$	80	59	2	200	2,000	64,000	0271010450805	4003530017193
	60	49	2	500	2,500	140,000	0271010500605	4003530017209
	70	61	2	200	2,000	64,000	0271010500705	4003530017216
	80	61*	2	200	2,000	64,000	0271010500805	4003530017223

*Modelo divergente. Rosca casi hasta la cabeza.

SPAX accesorios: Tapones de plástico SPAX para tornillo universal con taladro en la cabeza

Paquetes de 500 uds

Ver pág. 156



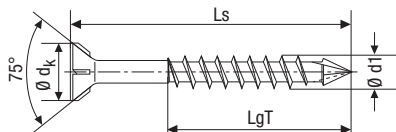

SPAX-M para MDF, cabeza plana

T-STAR plus, rosca parcial

Cabeza reducida de fresado de 75°, punta CUT

Endurecido, revestimiento sintético



A9J

Rosca- \varnothing	Dimensiones [mm]			Unidad de venta			N° SPAX	Cód. EAN
	Longitud total	Longitud rosca parcial	Tamaño Huella	SPAX Box [uds]	Embalaje de cartón [uds]	Palé		
d1	Ls	LgT	T					
Embalaje pequeño								
3.5 $\varnothing d_k =$ 6.0 mm	40	28	15	200	2,000	224,000	0441010350403	4003530168437
	45	30	15	200	2,000	126,000	0441010350453	4003530168444
	50	35	15	200	2,000	126,000	0441010350503	4003530168451
4.0 $\varnothing d_k =$ 7.0 mm	40	28	20	200	2,000	126,000	0441010400403	4003530168468
	45	30	20	200	2,000	126,000	0441010400453	4003530168475
	50	35	20	200	2,000	126,000	0441010400503	4003530168482
	60	40	20	100	1,000	63,000	0441010400603	4003530168499
4.5 $\varnothing d_k =$ 8.0 mm	45	30	20	200	2,000	126,000	0441010450453	4003530168505
	50	35	20	200	2,000	64,000	0441010450503	4003530168512





SPAX para suelos de madera, cabeza plana,
T-STAR *plus*, rosca de fijación

4CUT, MULTI-Cabeza

Endurecido, revestimiento sintético

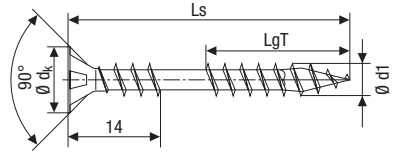

Rosca- Ø	Dimensiones [mm]			Unidad de venta			N° SPAX	Cód. EAN
	Longitud total	Longitud rosca parcial	Tamaño Huella	SPAX Box [uds]	Embalaje de cartón [uds]	Palé		
d1	Ls	LgT	T					
Embalaje estándar								
4.5 Ø dk = 8.8 mm	50	21	20	500	5,000	140,000	0541010450505	4003530246906
	60	26	20	500	5,000	140,000	0541010450605	4003530246913
	70	31	20	500	2,500	140,000	0541010450705	4003530246920
	80	31	20	200	2,000	64,000	0541010450805	4003530246937



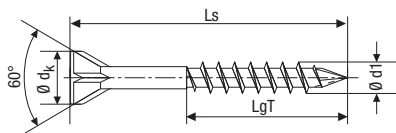

SPAX para suelos de madera maciza, cabeza plana,
T-STAR *plus*, rosca parcial

Cabeza de fresado reducido de 60°, punta CUT

Endurecido, revestimiento sintético



A9J

Rosca- \varnothing	Dimensiones [mm]			Unidad de venta			N° SPAX	Cód. EAN
	Longitud total	Longitud rosca parcial	Tamaño Huella	SPAX Box [uds]	Embalaje de cartón [uds]	Palé		
d1	Ls	LgT	T					
Embalaje pequeño								
3.5 $\varnothing d_k =$ 6.0 mm	35	20	10	500	5,000	160,000	35703503203011	4003530246944
	45	28	10	500	5,000	160,000	35703503201011	4003530246951
	55	35	10	500	5,000	160,000	35703503202011	4003530246968





Tornillo universal, cabeza plana,
T-Star plus, rosca completa

4CUT, MULTI-Cabeza

Endurecido, revestimiento sintético

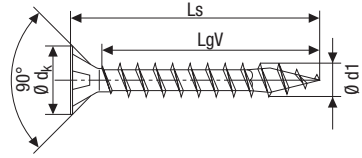

Rosca- Ø d1	Dimensiones [mm]			Unidad de venta			N° SPAX	Cód. EAN
	Longitud total Ls	Longitud rosca completa LgV	Tamaño Huella T	SPAX Box [uds]	Embalaje de cartón [uds]	Palé		
Embalaje estándar								
3.0* Ø dk = 6.0 mm	12	10	10	1,000	10,000	1,120,000	1191020300125	4003530010323
	16	14	10	1,000	10,000	1,120,000	1191020300165	4003530010354
	20	17	10	1,000	10,000	630,000	1191020300205	4003530010378
	25	21	10	1,000	10,000	630,000	1191020300255	4003530010385
Embalaje pequeño								
3.0* Ø dk = 6.0 mm	12	10	10	200	2,000	470,000	1191020300123	4003530090806
	16	14	10	200	2,000	470,000	1191020300163	4003530090813
	20	17	10	200	2,000	260,000	1191020300203	4003530090820
	25	21	10	200	2,000	260,000	1191020300253	4003530024504
Embalaje estándar								
3.5 Ø dk = 7.0 mm	16	13	20	1,000	10,000	630,000	1191020350165	4003530010439
	20	16	20	1,000	10,000	630,000	1191020350205	4003530010446
	25	21	20	1,000	10,000	320,000	1191020350255	4003530148972
Embalaje pequeño								
3.5 Ø dk = 7.0 mm	25	21	20	200	2,000	260,000	1191020350253	4003530156588
Embalaje estándar								
4.0 Ø dk = 8.0 mm	20	16	20	1,000	10,000	630,000	1191020400205	4003530010507
	25	21	20	1,000	10,000	320,000	1191020400255	4003530154607
Embalaje pequeño								
4.0 Ø dk = 8.0 mm	20	16	20	200	2,000	260,000	1191020400203	4003530090868
	25	21	20	200	2,000	260,000	1191020400253	4003530154195

*Modelo divergente.



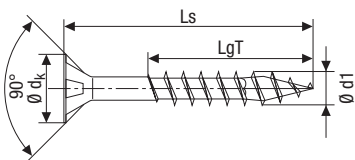

Tornillo universal, cabeza plana,
T-STAR plus, rosca parcial

4CUT, MULTI-Cabeza

Endurecido, revestimiento sintético



Rosca- \varnothing d1	Dimensiones [mm]			Unidad de venta			N° SPAX	Cód. EAN
	Longitud total Ls	Longitud rosca parcial LgT	Tamaño Huella T	SPAX Box [uds]	Embalaje de cartón [uds]	Palé		
Embalaje estándar								
3.0* $\varnothing d_k =$ 6.0 mm	30	18	10	1,000	10,000	320,000	0191020300305	4003530010392
	35	23	10	1,000	10,000	320,000	0191020300355	4003530010408
	40	23	10	1,000	10,000	280,000	0191020300405	4003530010415
Embalaje pequeño								
3.0* $\varnothing d_k =$ 6.0 mm	30	18	10	200	2,000	260,000	0191020300303	4003530024511
	35	23	10	200	2,000	260,000	0191020300353	4003530024528
	40	23	10	200	2,000	224,000	0191020300403	4003530024535
Embalaje estándar								
3.5 $\varnothing d_k =$ 7.0 mm	30	18	20	1,000	10,000	320,000	0191020350305	4003530010460
	35	23	20	1,000	10,000	320,000	0191020350355	4003530010477
	40	23	20	1,000	10,000	280,000	0191020350405	4003530010484
	45	30	20	1,000	10,000	280,000	0191020350455	4003530107788
	50	32	20	500	5,000	160,000	0191020350505	4003530107795
Embalaje pequeño								
3.5 $\varnothing d_k =$ 7.0 mm	30	18	20	200	2,000	260,000	0191020350303	4003530024566
	35	23	20	200	2,000	224,000	0191020350353	4003530024573
	40	23	20	200	2,000	224,000	0191020350403	4003530024580
	50	32	20	200	2,000	126,000	0191020350503	4003530090851

*Modelo divergente.





Tornillo universal, cabeza plana,
T-STAR plus, rosca parcial

4CUT, MULTI-Cabeza

Endurecido, revestimiento sintético

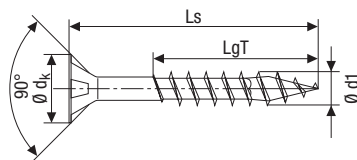

Rosca- Ø d1	Dimensiones [mm]			Tamaño Huella T	Unidad de venta			N° SPAX	Cód. EAN
	Longitud total Ls	Longitud rosca parcial LgT			SPAX Box [uds]	Embalaje de cartón [uds]	Palé		
Embalaje estándar									
4.0 Ø dk = 8.0 mm	30	18	20	1,000	10,000	320,000	0191020400305	4003530010521	
	35	23	20	1,000	10,000	280,000	0191020400355	4003530010538	
	40	23	20	1,000	10,000	280,000	0191020400405	4003530132889	
	45	30	20	500	5,000	160,000	0191020400455	4003530147081	
	50	32	20	500	5,000	140,000	0191020400505	4003530132896	
	60	35	20	500	5,000	140,000	0191020400605	4003530132902	
	70	37	20	500	2,500	140,000	0191020400705	4003530132919	
	80	37	20	200	2,000	64,000	0191020400805	4003530165665	
Embalaje pequeño									
4.0 Ø dk = 8.0 mm	30	18	20	200	2,000	224,000	0191020400303	4003530024603	
	35	23	20	200	2,000	224,000	0191020400353	4003530024610	
	40	23	20	200	2,000	126,000	0191020400403	4003530133213	
	45	30	20	200	2,000	126,000	0191020400453	4003530147111	
	50	32	20	200	2,000	126,000	0191020400503	4003530133220	
	60	35	20	100	1,000	63,000	0191020400603	4003530133237	
	70	37	20	100	1,000	32,000	0191020400703	4003530133244	
Embalaje estándar									
4.5 Ø dk = 8.8 mm	30	17	20	1,000	10,000	280,000	0191020450305	4003530010583	
	35	25	20	500	5,000	160,000	0191020450355	4003530010590	
	40	25	20	500	5,000	160,000	0191020450405	4003530132926	
	45	30	20	500	5,000	140,000	0191020450455	4003530147098	
	50	32	20	500	5,000	140,000	0191020450505	4003530132933	
	60	37	20	500	5,000	140,000	0191020450605	4003530132940	
	70	42	20	500	2,500	140,000	0191020450705	4003530132957	
	80	47	20	200	2,000	64,000	0191020450805	4003530132964	
Embalaje pequeño									
4.5 Ø dk = 8.8 mm	30	17	20	200	2,000	224,000	0191020450303	4003530024665	
	35	25	20	200	2,000	126,000	0191020450353	4003530024672	
	40	25	20	200	2,000	126,000	0191020450403	4003530133251	
	45	30	20	200	2,000	126,000	0191020450453	4003530147128	
	50	32	20	200	2,000	64,000	0191020450503	4003530133268	
	60	37	20	100	1,000	63,000	0191020450603	4003530133275	
	70	42	20	100	1,000	32,000	0191020450703	4003530133282	
	80	47	20	100	1,000	32,000	0191020450803	4003530133299	



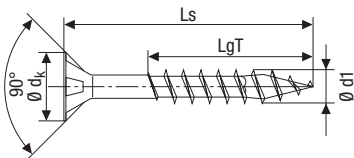

Tornillo universal, cabeza plana,
T-STAR plus, rosca parcial

4CUT, MULTI-Cabeza

Endurecido, revestimiento sintético



Rosca- Ø d1	Dimensiones [mm]			Unidad de venta			Nº SPAX	Cód. EAN
	Longitud total Ls	Longitud rosca parcial LgT	Tamaño Huella T	SPAX Box [uds]	Embalaje de cartón [uds]	Palé		
Embalaje estándar								
5.0 Ø dk = 9.7 mm	30	17	20	500	5,000	160,000	0191020500305	4003530010651
	35	25	20	500	5,000	160,000	0191020500355	4003530010668
	40	27	20	500	5,000	140,000	0191020500405	4003530010675
	45	30	20	500	5,000	140,000	0191020500455	4003530010682
	50	32	20	500	5,000	140,000	0191020500505	4003530132971
	55	37	20	500	5,000	140,000	0191020500555	4003530147104
	60	37	20	500	2,500	140,000	0191020500605	4003530132988
	70	41	20	200	2,000	64,000	0191020500705	4003530132995
	80	46	20	200	2,000	64,000	0191020500805	4003530133008
	90	61	20	200	2,000	64,000	0191020500905	4003530149511
	100	61	20	200	2,000	64,000	0191020501005	4003530133022
120	69	20	200	2,000	56,000	0191020501205	4003530133039	
Embalaje pequeño								
5.0 Ø dk = 9.7 mm	30	17	20	200	2,000	224,000	0191020500303	4003530024726
	40	27	20	200	2,000	126,000	0191020500403	4003530024740
	50	32	20	200	2,000	64,000	0191020500503	4003530133305
	60	37	20	100	1,000	63,000	0191020500603	4003530133312
	70	41	20	100	1,000	32,000	0191020500703	4003530133329
	80	46	20	100	1,000	32,000	0191020500803	4003530133336
	90	61	20	100	1,000	32,000	0191020500903	4003530133343
	100	61	20	100	1,000	32,000	0191020501003	4003530133350





Tornillo universal, cabeza plana,
T-STAR plus, rosca parcial

4CUT, MULTI-Cabeza

Endurecido, revestimiento sintético

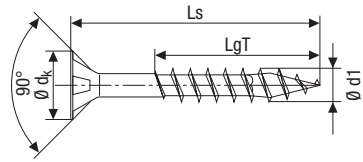

Rosca- Ø d1	Dimensiones [mm]			Unidad de venta			N° SPAX	Cód. EAN
	Longitud total L _s	Longitud rosca parcial L _{gT}	Tamaño Huella T	SPAX Box [uds]	Embalaje de cartón [uds]	Palé		
Embalaje estándar								
6.0 Ø d _k = 11.6 mm	40	24	30	500	2,500	140,000	0191020600405	4003530010750
	50	32	30	200	2,000	64,000	0191020600505	4003530010767
	60	37	30	200	2,000	56,000	0191020600605	4003530133046
	70	41	30	200	2,000	56,000	0191020600705	4003530133053
	80	46	30	200	2,000	56,000	0191020600805	4003530133060
	90	61	30	200	1,000	56,000	0191020600905	4003530147234
	100	61	30	100	1,000	32,000	0191020601005	4003530133084
	110	68	30	100	1,000	32,000	0191020601105	4003530133091
	120	68	30	100	1,000	28,000	0191020601205	4003530133107
	130	68	30	100	1,000	28,000	0191020601305	4003530133114
	140	68	30	100	1,000	28,000	0191020601405	4003530133121
	150	68	30	100	1,000	28,000	0191020601505	4003530133138
	160	65	30	100	1,000	28,000	0191020601605	4003530133145
	180	65	30	100	1,000	28,000	0191020601805	4003530133411
	200	65	30	100	1,000	24,000	0191020602005	4003530133152
	220	65	30	100	1,000	24,000	0191020602205	4003530133169
240	65	30	100	1,000	24,000	0191020602405	4003530133176	
260	65	30	100	-	9,600	0191020602605	4003530133183	
280	65	30	100	-	9,600	0191020602805	4003530133190	
300	65	30	100	-	9,600	0191020603005	4003530133206	
Embalaje pequeño								
6.0 Ø d _k = 11.6 mm	50	32	30	100	1,000	32,000	0191020600503	4003530024825
	60	37	30	100	1,000	32,000	0191020600603	4003530133367
	70	41	30	100	1,000	32,000	0191020600703	4003530133374
	80	46	30	100	1,000	32,000	0191020600803	4003530133381





SPAX®

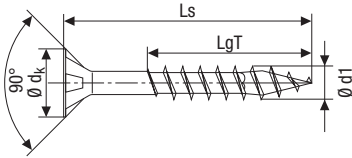

SPAX – Encintado – Sistema de bobina, cabeza plana
T-Star plus, rosca parcial

4CUT, MULTI-Cabeza

Endurecido, revestimiento sintético, encintado en bobina



Rosca- Ø d1	Dimensiones [mm]			SPAX encintado [uds]	Unidad de venta SPAX Box [uds]	N° SPAX	Cód. EAN
	Longitud total Ls	Longitud rosca parcial LgT	Tamaño Huella T				
Embalaje estándar							
3.5 Ø dk = 7.0 mm	25	18	20	200	1,200	0191020350256	4003530040405
	30	18	20	200	1,200	0191020350306	4003530040412
	35	23	20	200	1,200	0191020350356	4003530040429
	40	23	20	200	800	0191020350406	4003530040436
	45	30	20	200	800	0191020350456	4003530040443
	50	32	20	200	800	0191020350506	4003530040450
4.0 Ø dk = 8.0 mm	25	21*	20	200	1,200	11910204000256	4003530154850
	30	18	20	200	1,200	01910204000306	4003530040474
	35	23	20	200	1,200	01910204000356	4003530040481
	40	23	20	200	800	01910204000406	4003530040498
	45	30	20	200	800	01910204000456	4003530040504
	50	32	20	200	800	01910204000506	4003530040511
4.5 Ø dk = 8.8 mm	50	32	20	125	500	019102040006061	4003530097874
	55	37	20	125	500	0191020450556	4003530040542
5.0 Ø dk = 9.7 mm	60	41	20	125	500	21910205006061	4003530097898
	65	46	20	125	500	21910205006561	4003530170096
	70	51	20	125	500	21910205007061	4003530154836
	80	61	20	125	500	21910205008061	4003530097928



*Modelo divergente. Rosca casi hasta la cabeza.

Artículo bajo pedido





Tornillo universal, cabeza plana,
Ranura en cruz Z, rosca completa

Endurecido, revestimiento sintético

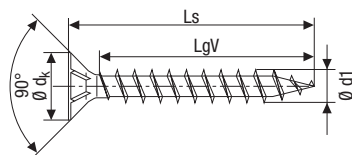

YELLOX **CHROM(VI) FREE** **A2L**



Rosca- Ø d1	Dimensiones [mm]			Unidad de venta			N° SPAX	Cód. EAN
	Longitud total Ls	Longitud rosca completa LgV	Tamaño Huella Z	SPAX Box [uds]	Embalaje de cartón [uds]	Palé		
Embalaje estándar								
2.0* Ø dk = 4.3 mm	10	8	1	1,000	10,000	1,120,000	1081020200105	4003530099977
	12	11	1	1,000	10,000	1,120,000	1081020200125	4003530099984
	16	15	1	1,000	10,000	1,120,000	1081020200165	4003530099991
2.5* Ø dk = 5.1 mm	10	8	1	1,000	10,000	1,120,000	1081020250105	4003530004636
	12	10	1	1,000	10,000	1,120,000	1081020250125	4003530004643
	16	14	1	1,000	10,000	1,120,000	1081020250165	4003530004650
	20	17	1	1,000	10,000	1,120,000	1081020250205	4003530004667
	25	22	1	1,000	10,000	630,000	1081020250255	4003530004674
3.0* Ø dk = 6.0 mm	10	7	1	1,000	10,000	1,120,000	1081020300105	4003530004681
	12	10	1	1,000	10,000	1,120,000	1081020300125	4003530004698
	16	14	1	1,000	10,000	1,120,000	1081020300165	4003530004704
	20	17	1	1,000	10,000	630,000	1081020300205	4003530004711
	25	21	1	1,000	10,000	630,000	1081020300255	4003530004728
	30	26	1	1,000	10,000	320,000	1081020300305	4003530004735
	35	31	1	1,000	10,000	320,000	1081020300355	4003530004742
	40	36	1	1,000	10,000	280,000	1081020300405	4003530004759
45	36*	1	1,000	10,000	280,000	1081020300455	4003530004766	
Embalaje pequeño								
3.0* Ø dk = 6.0 mm	12	10	1	200	2,000	470,000	1081020300123	4003530006616
	16	14	1	200	2,000	470,000	1081020300163	4003530006623
	20	17	1	200	2,000	260,000	1081020300203	4003530006630
	25	21	1	200	2,000	260,000	1081020300253	4003530006647
	30	26	1	200	2,000	260,000	1081020300303	4003530006654
	35	31	1	200	2,000	260,000	1081020300353	4003530006661
	40	36	1	200	2,000	224,000	1081020300403	4003530006678

*Modelo divergente.



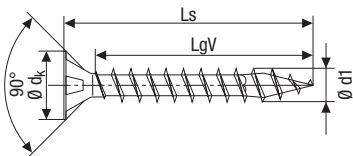

Tornillo universal, cabeza plana,

Ranura en cruz Z, rosca completa

4CUT, MULTI-Cabeza

Endurecido, revestimiento sintético



Rosca- Ø d1	Dimensiones [mm]			Unidad de venta			N° SPAX	Cód. EAN
	Longitud total Ls	Longitud rosca completa LgV	Tamaño Huella Z	SPAX Box [uds]	Embalaje de cartón [uds]	Palé		
Embalaje estándar								
3.5 Ø dk = 7.0 mm	12	9	2	1,000	10,000	1,120,000	1081020350125	4003530004773
	15	11	2	1,000	10,000	630,000	1081020350155	4003530009532
	16	13	2	1,000	10,000	630,000	1081020350165	4003530004780
	20	16	2	1,000	10,000	630,000	1081020350205	4003530004797
	25	21	2	1,000	10,000	320,000	1081020350255	4003530004803
	30	25	2	1,000	10,000	320,000	1081020350305	4003530004810
	35	30	2	1,000	10,000	320,000	1081020350355	4003530004827
	40	35	2	1,000	10,000	280,000	1081020350405	4003530004834
	45	40	2	1,000	10,000	280,000	1081020350455	4003530004841
50	40*	2	500	5,000	160,000	1081020350505	4003530004858	
Embalaje pequeño								
3.5 Ø dk = 7.0 mm	12	9	2	200	2,000	470,000	1081020350123	4003530006685
	16	13	2	200	2,000	260,000	1081020350163	4003530006692
	20	16	2	200	2,000	260,000	1081020350203	4003530006708
	25	21	2	200	2,000	260,000	1081020350253	4003530006715
	30	25	2	200	2,000	260,000	1081020350303	4003530006722
	35	30	2	200	2,000	224,000	1081020350353	4003530006739
	40	35	2	200	2,000	224,000	1081020350403	4003530006746
	45	40	2	200	2,000	126,000	1081020350453	4003530006753
	50	40*	2	200	2,000	126,000	1081020350503	4003530006760

*Modelo divergente. Rosca casi hasta la cabeza.





Tornillo universal, cabeza plana,

Ranura en cruz Z, rosca completa

4CUT, MULTI-Cabeza

Endurecido, revestimiento sintético

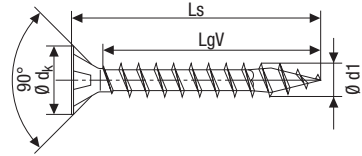

YELLOX

**CHROM(VI)
FREE**

A2L



Rosca- Ø d1	Dimensiones [mm]			Unidad de venta			N° SPAX	Cód. EAN
	Longitud total Ls	Longitud rosca completa LgV	Tamaño Huella Z	SPAX Box [uds]	Embalaje de cartón [uds]	Palé		
Embalaje estándar								
4.0 Ø d _k = 8.0 mm	12	9	2	1,000	10,000	630,000	1081020400125	4003530004865
	15	11	2	1,000	10,000	630,000	1081020400155	4003530009556
	16	13	2	1,000	10,000	630,000	1081020400165	4003530004872
	20	16	2	1,000	10,000	630,000	1081020400205	4003530004889
	25	21	2	1,000	10,000	320,000	1081020400255	4003530004896
	30	25	2	1,000	10,000	320,000	1081020400305	4003530004902
	35	30	2	1,000	10,000	280,000	1081020400355	4003530004919
	40	35	2	1,000	10,000	280,000	1081020400405	4003530004926
	45	40	2	500	5,000	160,000	1081020400455	4003530004933
	50	45	2	500	5,000	140,000	1081020400505	4003530004940
	55	50	2	500	5,000	140,000	1081020400555	4003530004957
60	50*	2	500	5,000	140,000	1081020400605	4003530004964	
70	50*	2	500	2,500	140,000	1081020400705	4003530004971	
80	50*	2	200	2,000	64,000	1081020400805	4003530004009	
Embalaje pequeño								
4.0 Ø d _k = 8.0 mm	16	13	2	200	2,000	260,000	1081020400163	4003530006777
	20	16	2	200	2,000	260,000	1081020400203	4003530006784
	25	21	2	200	2,000	260,000	1081020400253	4003530006791
	30	25	2	200	2,000	224,000	1081020400303	4003530006807
	35	30	2	200	2,000	224,000	1081020400353	4003530006814
	40	35	2	200	2,000	126,000	1081020400403	4003530006821
	45	40	2	200	2,000	126,000	1081020400453	4003530006838
	50	45	2	200	2,000	126,000	1081020400503	4003530006845
	60	50*	2	100	1,000	63,000	1081020400603	4003530006852
70	50*	2	100	1,000	32,000	1081020400703	4003530006869	

*Modelo divergente. Rosca casi hasta la cabeza.



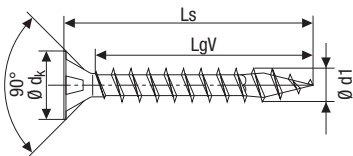

Tornillo universal, cabeza plana,

Ranura en cruz Z, rosca completa

4CUT, MULTI-Cabeza

Endurecido, revestimiento sintético



Rosca- Ø d1	Dimensiones [mm]			Unidad de venta			N° SPAX	Cód. EAN
	Longitud total Ls	Longitud rosca completa LgV*	Tamaño Huella Z	SPAX Box [uds]	Embalaje de cartón [uds]	Palé		
Embalaje estándar								
4.5 Ø dk = 8.8 mm	16	13	2	1,000	10,000	640,000	1081020450165	4003530004988
	20	15	2	1,000	10,000	320,000	1081020450205	4003530004995
	25	20	2	1,000	10,000	320,000	1081020450255	4003530005008
	30	25	2	1,000	10,000	280,000	1081020450305	4003530005015
	35	30	2	500	5,000	160,000	1081020450355	4003530005022
	40	34	2	500	5,000	160,000	1081020450405	4003530005039
	45	39	2	500	5,000	140,000	1081020450455	4003530005046
	50	44	2	500	5,000	140,000	1081020450505	4003530005053
	60	54	2	500	5,000	140,000	1081020450605	4003530005077
70	59*	2	500	2,500	140,000	1081020450705	4003530005084	
80	59*	2	200	2,000	64,000	1081020450805	4003530005091	
Embalaje pequeño								
4.5 Ø dk = 8.8 mm	16	13	2	200	2,000	260,000	1081020450163	4003530006876
	20	15	2	200	2,000	260,000	1081020450203	4003530006883
	25	20	2	200	2,000	224,000	1081020450253	4003530006890
	30	25	2	200	2,000	224,000	1081020450303	4003530006906
	35	30	2	200	2,000	126,000	1081020450353	4003530006913
	40	34	2	200	2,000	126,000	1081020450403	4003530006920
	45	39	2	200	2,000	126,000	1081020450453	4003530006937
	50	44	2	200	2,000	64,000	1081020450503	4003530006944
	60	54	2	100	1,000	63,000	1081020450603	4003530006951
70	59*	2	100	1,000	32,000	1081020450703	4003530006968	
80	59*	2	100	1,000	32,000	1081020450803	4003530006975	

*Modelo divergente. Rosca casi hasta la cabeza.





Tornillo universal, cabeza plana,

Ranura en cruz Z, rosca completa

4CUT, MULTI-Cabeza

Endurecido, revestimiento sintético

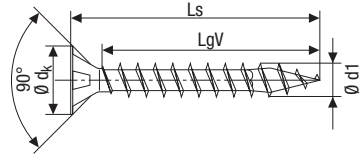

YELLOX

**CHROM(VI)
FREE**

A2L



Rosca- Ø	Dimensiones [mm]			Unidad de venta			N° SPAX	Cód. EAN
	Longitud total	Longitud rosca completa	Tamaño Huella	SPAX Box [uds]	Embalaje de cartón [uds]	Palé		
d1	Ls	LgV	Z					
Embalaje estándar								
5.0 Ø dk = 9.7 mm	20	15	2	1,000	10,000	320,000	1081020500205	4003530005114
	25	20	2	1,000	10,000	320,000	1081020500255	4003530005121
	30	25	2	500	5,000	160,000	1081020500305	4003530005138
	35	30	2	500	5,000	160,000	1081020500355	4003530005145
	40	35	2	500	5,000	140,000	1081020500405	4003530005152
	45	39	2	500	5,000	140,000	1081020500455	4003530005169
	50	44	2	500	5,000	140,000	1081020500505	4003530005176
	60	54	2	500	2,500	140,000	1081020500605	4003530005190
	70	61*	2	200	2,000	64,000	1081020500705	4003530005206
80	61*	2	200	2,000	64,000	1081020500805	4003530005213	
Embalaje pequeño								
5.0 Ø dk = 9.7 mm	20	15	2	200	2,000	260,000	1081020500203	4003530006982
	25	20	2	200	2,000	224,000	1081020500253	4003530006999
	30	25	2	200	2,000	224,000	1081020500303	4003530007002
	35	30	2	200	2,000	126,000	1081020500353	4003530007019
	40	35	2	200	2,000	126,000	1081020500403	4003530007026
	45	39	2	200	2,000	126,000	1081020500453	4003530007033
	50	44	2	200	2,000	64,000	1081020500503	4003530007040
	60	54	2	100	1,000	63,000	1081020500603	4003530007057
	70	61*	2	100	1,000	32,000	1081020500703	4003530007064
80	61*	2	100	1,000	32,000	1081020500803	4003530007071	

*Modelo divergente. Rosca casi hasta la cabeza.



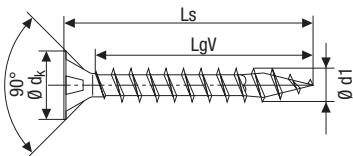

Tornillo universal, cabeza plana,

Ranura en cruz Z, rosca completa

4CUT, MULTI-Cabeza

Endurecido, revestimiento sintético



Rosca- \varnothing d1	Dimensiones [mm]			Unidad de venta			N° SPAX	Cód. EAN
	Longitud total Ls	Longitud rosca completa LgV	Tamaño Huella Z	SPAX Box [uds]	Embalaje de cartón [uds]	Palé		
Embalaje estándar								
6.0 $\varnothing d_k = 11.6 \text{ mm}$	30	24	3	500	5,000	160,000	1081020600305	4003530005268
	35	29	3	500	5,000	140,000	1081020600355	4003530009570
	40	34	3	500	2,500	140,000	1081020600405	4003530005275
	45	38	3	500	2,500	140,000	1081020600455	4003530005282
	50	43	3	200	2,000	64,000	1081020600505	4003530005299
	60	53	3	200	2,000	56,000	1081020600605	4003530005312
	70	61*	3	200	2,000	56,000	1081020600705	4003530005329
	80	61*	3	200	2,000	56,000	1081020600805	4003530005336
Embalaje pequeño								
6.0 $\varnothing d_k = 11.6 \text{ mm}$	40	34	3	200	2,000	64,000	1081020600403	4003530007095
	50	43	3	100	1,000	32,000	1081020600503	4003530012136
	60	53	3	100	1,000	32,000	1081020600603	4003530007118
	70	61*	3	100	1,000	32,000	1081020600703	4003530007125
	80	61*	3	100	1,000	32,000	1081020600803	4003530007132



*Modelo divergente. Rosca casi hasta la cabeza.

Artículo discontinuado





Tornillo universal , cabeza plana,

Ranura en cruz Z, rosca parcial

4CUT, MULTI-Cabeza

Endurecido, revestimiento sintético

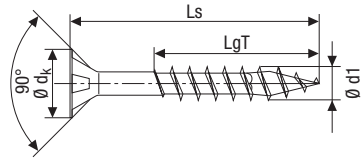

Rosca- Ø d1	Dimensiones [mm]			Unidad de venta			N° SPAX	Cód. EAN
	Longitud total Ls	Longitud rosca parcial LgT	Tamaño Huella Z	SPAX Box [uds]	Embalaje de cartón [uds]	Palé		
Embalaje estándar								
3.5 Ø dk = 7.0 mm	35	23	2	1,000	10,000	320,000	0291020350355	4003530010002
	40	23	2	1,000	10,000	280,000	0291020350405	4003530010019
	45	30	2	1,000	10,000	280,000	0291020350455	4003530039829
	50	32	2	500	5,000	160,000	0291020350505	4003530039836
4.0 Ø dk = 8.0 mm	35	23	2	1,000	10,000	280,000	0291020400355	4003530010033
	40	23	2	1,000	10,000	280,000	0291020400405	4003530010040
	45	30	2	500	5,000	160,000	0291020400455	4003530010057
	50	32	2	500	5,000	140,000	0291020400505	4003530010064
	55	35	2	500	5,000	140,000	0291020400555	4003530023064
4.5 Ø dk = 8.8 mm	60	35	2	500	5,000	140,000	0291020400605	4003530010071
	40	25	2	500	5,000	160,000	0291020450405	4003530010118
	45	30	2	500	5,000	140,000	0291020450455	4003530010125
	50	32	2	500	5,000	140,000	0291020450505	4003530010132
	60	37	2	500	5,000	140,000	0291020450605	4003530010156
	70	42	2	500	2,500	140,000	0291020450705	4003530010163



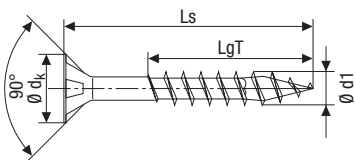

Tornillo universal, cabeza plana

Ranura en cruz Z, rosca parcial

4CUT, MULTI-Cabeza

Endurecido, revestimiento sintético



Rosca- Ø d1	Dimensiones [mm]			Unidad de venta			N° SPAX	Cód. EAN
	Longitud total Ls	Longitud rosca parcial LgT	Tamaño Huella Z	SPAX Box [uds]	Embalaje de cartón [uds]	Palé		
Embalaje estándar								
5.0 Ø dk = 9.7 mm	50	32	2	500	5,000	140,000	0291020500505	4003530010200
	60	37	2	500	2,500	140,000	0291020500605	4003530010217
	70	41	2	200	2,000	64,000	0291020500705	4003530010224
	80	46	2	200	2,000	64,000	0291020500805	4003530010231
	90	61	2	200	2,000	64,000	1081020500905	4003530005220
	100	61	2	200	2,000	64,000	1081020501005	4003530005237
	110	69	2	200	2,000	64,000	1081020501105	4003530005244
120	69	2	200	2,000	56,000	1081020501205	4003530005251	
Embalaje pequeño								
5.0 Ø dk = 9.7 mm	80	46	2	100	1,000	32,000	0291020500803	4003530011597
	90	61	2	100	1,000	32,000	1081020500903	4003530009594
	100	61	2	100	1,000	32,000	1081020501003	4003530007088





Tornillo universal, cabeza plana,

Ranura en cruz Z, rosca parcial

4CUT, MULTI-Cabeza

Endurecido, revestimiento sintético

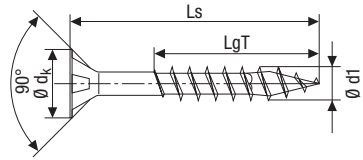

YELLOX

**CHROM(VI)
FREE**

A2L



Rosca- Ø d1	Dimensiones [mm]			Unidad de venta			N° SPAX	Cód. EAN
	Longitud total Ls	Longitud rosca parcial LgT	Tamaño Huella Z	SPAX Box [uds]	Embalaje de cartón [uds]	Palé		
Embalaje estándar								
6.0 Ø dk = 11.6 mm	60	37	3	200	2,000	56,000	0291020600605	4003530010279
	70	41	3	200	2,000	56,000	0291020600705	4003530010286
	80	46	3	200	2,000	56,000	0291020600805	4003530010293
	90	61	3	200	1,000	56,000	1081020600905	4003530005343
	100	61	3	100	1,000	32,000	1081020601005	4003530005350
	120	68	3	100	1,000	28,000	1081020601205	4003530005374
	140	68	3	100	1,000	28,000	1081020601405	4003530005398
	160	65	3	100	1,000	28,000	1081020601605	4003530005411
	180	65	3	100	1,000	28,000	1081020601805	4003530005428
Embalaje pequeño								
6.0 Ø dk = 11.6 mm	90	61	3	100	1,000	32,000	1081020600903	4003530007149

Artículo discontinuado



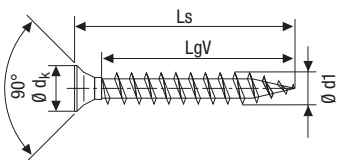

Tornillo universal, cabeza plana,

Ranura en cruz Z, rosca completa

Cabeza reducida (Ø 5 mm)

Endurecido, revestimiento sintético



Rosca- Ø d1	Dimensiones [mm]			Unidad de venta			N° SPAX	Cód. EAN
	Longitud total Ls	Longitud rosca completa LgV	Tamaño Huella Z	SPAX Box [uds]	Embalaje de cartón [uds]	Palé		
<i>Embalaje estándar</i>								
3.0	10	7	1	1,000	10,000	1,120,000	0321020300105	4003530106705
Ø dk =	12	10	1	1,000	10,000	1,120,000	0321020300125	4003530017667
5.1 mm	15	12	1	1,000	10,000	1,120,000	0321020300155	4003530017681





SPAX – Encintado – Sistema de bobina, cabeza plana,

Ranura en cruz Z, rosca completa

4CUT, MULTI-Cabeza

Endurecido, revestimiento sintético, encintado en bobina

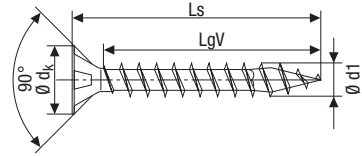

Rosca- Ø	Dimensiones [mm]		Tamaño Huella Z	SPAX en bobina [uds]	Unidad de venta SPAX Box [uds]	N° SPAX	Cód. EAN
	Longitud total Ls	Longitud rosca completa LgV					
d1	Ls	LgV	Z				
Embalaje estándar							
3.5 Ø dk = 7.0 mm	25	21	2	200	1,200	1081020350256	4003530040603
	30	25	2	200	1,200	1081020350306	4003530040610
	35	30	2	200	1,200	1081020350356	4003530040627
	40	35	2	200	800	1081020350406	4003530040634
	45	40	2	200	800	1081020350456	4003530040641
4.0 Ø dk = 8.0 mm	50	40*	2	200	800	1081020350506	4003530040658
	25	21	2	200	1,200	1081020400256	4003530040665
	30	25	2	200	1,200	1081020400306	4003530040672
	35	30	2	200	1,200	1081020400356	4003530040689
	40	35	2	200	800	1081020400406	4003530040696
	45	40	2	200	800	1081020400456	4003530040702
4.5 Ø dk = 8.8 mm	50	45	2	200	800	1081020400506	4003530040719
	60	50*	2	200	800	1081020400606	4003530040726
	50	44	2	125	500	1081020450506	4003530040733
5.0 Ø dk = 9.7 mm	55	49	2	125	500	1081020450556	4003530040740
	60	54	2	125	500	1081020500606	4003530040764
	65	59	2	125	500	1081020500656	4003530040771
	70	61*	2	125	500	1081020500706	4003530040788
	80	61*	2	125	500	1081020500806	4003530040795

*Modelo divergente. Rosca casi hasta la cabeza. Artículo bajo pedido



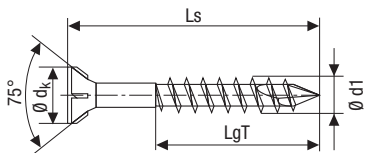

SPAX para listones de madera, cabeza plana

Ranura en cruz Z

Nervios fresadores, punta CUT

Revestimiento sintético



Rosca- Ø d1	Dimensiones [mm]			Unidad de venta			Nº SPAX	Cód. EAN
	Longitud total Ls	Longitud rosca parcial LgT	Tamaño Huella Z	SPAX Box [uds]	Embalaje de cartón [uds]	Palé		
Embalaje estándar								
3.5 Ø dk = 6.1 mm	40	23	2	200	2,000	224,000	35703503301022	4003530168413





Tornillo universal, cabeza plana,

Ranura en cruz Z, rosca completa

4CUT, MULTI-Cabeza

Endurecido, revestimiento sintético

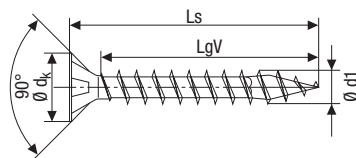

Bronce **C1A**



Rosca- Ø	Dimensiones [mm]			Unidad de venta			N° SPAX	Cód. EAN
	Longitud total	Longitud rosca completa LgV	Tamaño Huella Z	SPAX Box [uds]	Embalaje de cartón [uds]	Palé		
d1	Ls	LgV	Z					
Embalaje estándar								
2.5* Ø dk = 5.1 mm	12	10	1	1,000	10,000	1,120,000	1081140250125	4003530018091
	16	14	1	1,000	10,000	1,120,000	1081140250165	4003530018107
	20	17	1	1,000	10,000	1,120,000	1081140250205	4003530018114
3.0* Ø dk = 6.0 mm	12	10	1	1,000	10,000	1,120,000	1081140300125	4003530018145
	16	14	1	1,000	10,000	1,120,000	1081140300165	4003530018152
	20	17	1	1,000	10,000	630,000	1081140300205	4003530018176
	25	21	1	1,000	10,000	630,000	1081140300255	4003530018183
	30	26	1	1,000	10,000	320,000	1081140300305	4003530018190
	35	31	1	1,000	10,000	320,000	1081140300355	4003530018206
	40	36	1	1,000	10,000	280,000	1081140300405	4003530018213
3.5 Ø dk = 7.0 mm	12	9	2	1,000	10,000	1,120,000	1081140350125	4003530018220
	16	13	2	1,000	10,000	630,000	1081140350165	4003530018244
	20	16	2	1,000	10,000	630,000	1081140350205	4003530018251
	25	21	2	1,000	10,000	320,000	1081140350255	4003530018268
	30	25	2	1,000	10,000	320,000	1081140350305	4003530018275
	35	30	2	1,000	10,000	320,000	1081140350355	4003530018282
	40	35	2	1,000	10,000	280,000	1081140350405	4003530018299
	45	40	2	1,000	10,000	280,000	1081140350455	4003530018305
	50	40**	2	500	5,000	160,000	1081140350505	4003530018312
4.0 Ø dk = 8.0 mm	16	13	2	1,000	10,000	630,000	1081140400165	4003530018329
	20	16	2	1,000	10,000	630,000	1081140400205	4003530018336
	25	21	2	1,000	10,000	320,000	1081140400255	4003530018343
	30	25	2	1,000	10,000	320,000	1081140400305	4003530018350
	35	30	2	1,000	10,000	280,000	1081140400355	4003530018367
	40	35	2	1,000	10,000	280,000	1081140400405	4003530018374
	45	40	2	500	5,000	160,000	1081140400455	4003530018381
	50	45	2	500	5,000	140,000	1081140400505	4003530018398
	60	50**	2	500	5,000	140,000	1081140400605	4003530018404
	70	50**	2	500	2,500	140,000	1081140400705	4003530018411

*Modelo divergente.

**Modelo divergente. Rosca casi hasta la cabeza.



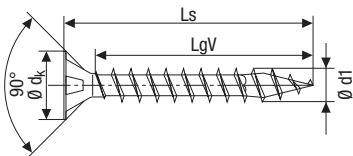

Tornillo universal, cabeza plana,

Ranura en cruz Z, rosca completa

4CUT, MULTI-Cabeza

Endurecido, revestimiento sintético

Bronce

C1A

Rosca- Ø d1	Dimensiones [mm]			Unidad de venta			N° SPAX	Cód. EAN
	Longitud total Ls	Longitud rosca completa LgV	Tamaño Huella Z	SPAX Box [uds]	Embalaje de cartón [uds]	Palé		
Embalaje estándar								
4.5 Ø dk = 8.8 mm	25	20	2	1,000	10,000	320,000	1081140450255	4003530018435
	30	25	2	1,000	10,000	280,000	1081140450305	4003530018442
	35	30	2	500	5,000	160,000	1081140450355	4003530018459
	40	34	2	500	5,000	160,000	1081140450405	4003530018466
	45	39	2	500	5,000	140,000	1081140450455	4003530018473
	50	44	2	500	5,000	140,000	1081140450505	4003530018480
	60	54	2	500	5,000	140,000	1081140450605	4003530018497
	70	59*	2	500	2,500	140,000	1081140450705	4003530018503
5.0 Ø dk = 9.7 mm	80	59*	2	200	2,000	64,000	1081140450805	4003530018510
	30	25	2	500	5,000	160,000	1081140500305	4003530018527
	35	30	2	500	5,000	160,000	1081140500355	4003530018534
	40	35	2	500	5,000	140,000	1081140500405	4003530018541
	45	39	2	500	5,000	140,000	1081140500455	4003530018558
	50	44	2	500	5,000	140,000	1081140500505	4003530018565
	60	54	2	500	2,500	140,000	1081140500605	4003530018572
	70	61*	2	200	2,000	64,000	1081140500705	4003530018589
6.0 Ø dk = 11.6 mm	80	61*	2	200	2,000	64,000	1081140500805	4003530018596
	50	43	3	200	2,000	64,000	1081140600505	4003530018633
	60	53	3	200	2,000	56,000	1081140600605	4003530018640
	70	61	3	200	2,000	56,000	1081140600705	4003530018657
	80	61*	3	200	2,000	56,000	1081140600805	4003530018664

*Modelo divergente. Rosca casi hasta la cabeza.





Tornillo universal, cabeza plana,

Ranura en cruz Z, rosca parcial

4CUT, MULTI-Cabeza

Endurecido, revestimiento sintético

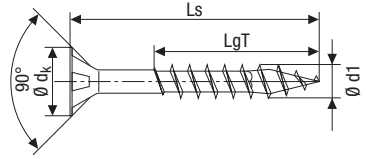

Bronce

C1A



Rosca- Ø	Dimensiones [mm]			Tamaño Huella Z	Unidad de venta			N° SPAX	Cód. EAN
	Longitud total	Longitud rosca parcial	LgT		SPAX Box [uds]	Embalaje de cartón [uds]	Palé		
d1	Ls	LgT							
<i>Embalaje estándar</i>									
5.0 Ø dk = 9.7 mm	90	61	2	200	2,000	64,000	1081140500905	4003530018602	
6.0 Ø dk = 11.6 mm	100	61	3	100	1,000	32,000	1081140601005	4003530018688	
	120	68	3	100	1,000	28,000	1081140601205	4003530018695	





Tornillo universal, cabeza plana,

T-Star plus, rosca completa

4CUT, MULTI-Cabeza

Revestimiento sintético

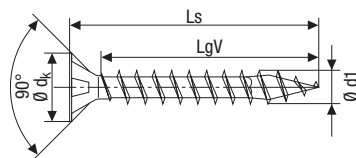

Acero inoxidable A2 1.4567

A2
AISI 304



Rosca- \varnothing	Dimensiones [mm]			Unidad de venta	N° SPAX	Cód. EAN		
	Longitud total	Longitud rosca completa	Tamaño Huella					
d1	Ls	LgV	T	SPAX Box [uds]	Embalaje de cartón [uds]	Palé		
Embalaje pequeño								
3.0* $\varnothing d_k = 6.0$ mm	12	10	10	200	2,000	470,000	1197000300123	4003530167980
	16	14	10	200	2,000	470,000	1197000300163	4003530167997
	20	17	10	200	2,000	260,000	1197000300203	4003530168000
	25	21	10	200	2,000	260,000	1197000300253	4003530168017
	30	26	10	200	2,000	260,000	1197000300303	4003530168024
	35	31	10	200	2,000	260,000	1197000300353	4003530168031
	40	36	10	200	2,000	224,000	1197000300403	4003530168048
3.5 $\varnothing d_k = 7.0$ mm	16	13	15	200	2,000	260,000	1197000350163	4003530156052
	20	16	15	200	2,000	260,000	1197000350203	4003530156069
	25	21	15	200	2,000	260,000	1197000350253	4003530157042
	30	25	15	200	2,000	260,000	1197000350303	4003530168055
	35	30	15	200	2,000	224,000	1197000350353	4003530168062
	40	35	15	200	2,000	224,000	1197000350403	4003530168079
4.0 $\varnothing d_k = 8.0$ mm	20	16	20	200	2,000	260,000	1197000400203	4003530156076
	25	21	20	200	2,000	260,000	1197000400253	4003530157059
	30	25	20	200	2,000	224,000	1197000400303	4003530168086
	35	30	20	200	2,000	224,000	1197000400353	4003530168093
	40	35	20	200	2,000	126,000	1197000400403	4003530168109
	45	40	20	200	2,000	126,000	1197000400453	4003530168116
	50	45	20	200	2,000	126,000	1197000400503	4003530168123
	60	50**	20	100	1,000	63,000	1197000400603	4003530168130
4.5 $\varnothing d_k = 8.8$ mm	25	20	20	200	2,000	224,000	1197000450253	4003530168147
	30	25	20	200	2,000	224,000	1197000450303	4003530168154
	35	30	20	200	2,000	126,000	1197000450353	4003530168161
	40	34	20	200	2,000	126,000	1197000450403	4003530168178
	45	39	20	200	2,000	126,000	1197000450453	4003530168185
	50	44	20	200	2,000	64,000	1197000450503	4003530168192
	60	54	20	100	1,000	63,000	1197000450603	4003530168208
	70	59**	20	100	1,000	63,000	1197000450703	4003530168215

*Modelo divergente.

**Modelo divergente. Rosca casi hasta la cabeza.



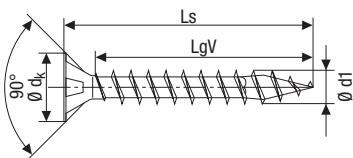

Tornillo universal, cabeza plana,
T-Star plus, rosca completa

4CUT, MULTI-Cabeza

Revestimiento sintético

Acero inoxidable A2 1.4567

A2
AISI 304

Rosca- \varnothing d_1	Dimensiones [mm]			Unidad de venta			N° SPAX	Cód. EAN
	Longitud total L_s	Longitud rosca completa $L_g V$	Tamaño Huella T	SPAX Box [uds]	Embalaje de cartón [uds]	Palé		
Embalaje pequeño								
5.0 $\varnothing d_k = 9.7 \text{ mm}$	30	25	20	200	2,000	224,000	1197000500303	4003530168222
	35	30	20	200	2,000	126,000	1197000500353	4003530168239
	40	35	20	200	2,000	126,000	1197000500403	4003530168246
	45	39	20	200	2,000	126,000	1197000500453	4003530168253
	50	44	20	200	2,000	64,000	1197000500503	4003530168260
	60	54	20	100	1,000	63,000	1197000500603	4003530168277
	70	61*	20	100	1,000	32,000	1197000500703	4003530168284
80	61*	20	100	1,000	32,000	1197000500803	4003530168291	
6.0 $\varnothing d_k = 11.6 \text{ mm}$	40	34	30	200	2,000	64,000	1197000600403	4003530168321
	50	43	30	100	1,000	32,000	1197000600503	4003530168345
	60	53	30	100	1,000	32,000	1197000600603	4003530168352
	70	61*	30	100	1,000	32,000	1197000600703	4003530168369
	80	61*	30	100	1,000	32,000	1197000600803	4003530168376

*Modelo divergente. Rosca casi hasta la cabeza.





Tornillo universal, cabeza plana,

T-Star plus, rosca parcial

4CUT, MULTI-Cabeza

Revestimiento sintético

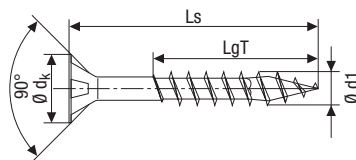

Acero inoxidable A2 1.4567

A2
AISI 304



Rosca- Ø d1	Dimensiones [mm]			Unidad de venta			N° SPAX	Cód. EAN
	Longitud total Ls	Longitud rosca parcial LgT	Tamaño Huella T	SPAX Box [uds]	Embalaje de cartón [uds]	Palé		
Embalaje pequeño								
3.5 Ø dk = 7.0 mm	30	18	15	200	2,000	260,000	0197000350303	4003530091803
	35	23	15	200	2,000	224,000	0197000350353	4003530091810
	40	23	15	200	2,000	224,000	0197000350403	4003530091827
4.0 Ø dk = 8.0 mm	30	18	20	200	2,000	224,000	0197000400303	4003530091834
	35	23	20	200	2,000	224,000	0197000400353	4003530091841
	40	23	20	200	2,000	126,000	0197000400403	4003530091858
	45	30	20	200	2,000	126,000	0197000400453	4003530091865
4.5 Ø dk = 8.8 mm	50	32	20	200	2,000	126,000	0197000400503	4003530091872
	40	25	20	200	2,000	126,000	0197000450403	4003530091889
	45	30	20	200	2,000	126,000	0197000450453	4003530091896
5.0 Ø dk = 9.7 mm	50	32	20	200	2,000	64,000	0197000450503	4003530091902
	60	37	20	100	1,000	63,000	0197000450603	4003530091919
	70	42	20	100	1,000	63,000	0197000450703	4003530097096
	40	27	20	200	2,000	126,000	0197000500403	4003530091926
	45	30	20	200	2,000	126,000	0197000500453	4003530091933
6.0 Ø dk = 11.6 mm	50	32	20	200	2,000	64,000	0197000500503	4003530091940
	60	37	20	100	1,000	63,000	0197000500603	4003530091957
	70	41	20	100	1,000	32,000	0197000500703	4003530091964
	80	46	20	100	1,000	32,000	0197000500803	4003530091971
	90	61	20	100	1,000	32,000	0197000500903	4003530097751
	100	61	20	100	1,000	32,000	0197000501003	4003530097768
	120	69	20	100	1,000	32,000	0197000501203	4003530098710
6.0 Ø dk = 11.6 mm	60	37	30	100	1,000	32,000	0197000600603	4003530091988
	70	41	30	100	1,000	32,000	0197000600703	4003530091995
	80	46	30	100	1,000	32,000	0197000600803	4003530092008
	90	61	30	100	1,000	32,000	0197000600903	4003530092015
	100	61	30	100	1,000	32,000	0197000601003	4003530092022
	120	68	30	100	1,000	32,000	0197000601203	4003530097775
	140	68	30	100	1,000	32,000	0197000601403	4003530097782
	160	65	30	100	1,000	32,000	0197000601603	4003530098727



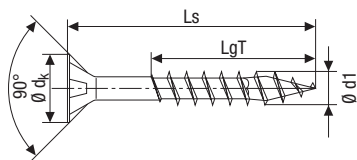

Tornillo universal, cabeza plana,

T-Star *plus*, rosca parcial

4CUT, MULTI-Cabeza

Revestimiento sintético

Acero inoxidable A2 1.4567

A2
AISI 304

Rosca- Ø d1	Dimensiones [mm]			Unidad de venta			N° SPAX	Cód. EAN
	Longitud total Ls	Longitud rosca parcial LgT	Tamaño Huella T	SPAX Box [uds]	Embalaje de cartón [uds]	Palé		
Embalaje estándar								
8.0 Ø dk = 15,1 mm	80	47	40	50	500	14,000	0197000800805	4003530257292
	100	57	40	50	500	14,000	0197000801005	4003530257308
	120	70	40	50	500	14,000	0197000801205	4003530257315
	140	80	40	50	500	14,000	0197000801405	4003530257322
	160	80	40	50	500	14,000	0197000801605	4003530257339
	180	80	40	50	500	14,000	0197000801805	4003530257346
	200	80	40	50	500	12,000	0197000802005	4003530257353
	220	80	40	50	500	12,000	0197000802205	4003530257360
	240	80	40	50	-	4,800	0197000802405	4003530257377
	260	80	40	50	-	4,800	0197000802605	4003530257384
	280	80	40	50	-	4,800	0197000802805	4003530257391
	300	80	40	50	-	4,800	0197000803005	4003530257407



NUEVO

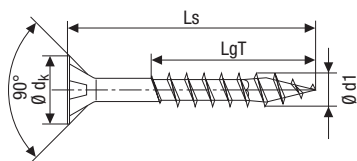

SPAX – Encintado – Sistema de bobina, cabeza plana,

T-Star *plus*, rosca parcial

4CUT, MULTI-Cabeza

Revestimiento sintético, encintado en bobina

Acero inoxidable A2 1.4567

A2
AISI 304

Rosca- Ø d1	Dimensiones [mm]			SPAX en bobina [uds]	Unidad de venta SPAX Box [uds]	N° SPAX	Cód. EAN
	Longitud total Ls	Longitud rosca parcial LgT	Tamaño Huella T				
Embalaje estándar							
4.0 Ø dk = 8.0 mm	30	18	20	200	800	0197000400306	4003530040801
	35	23	20	200	800	0197000400356	4003530040818
	45	30	20	200	800	0197000400456	4003530175831
4.5 Ø dk = 8.8 mm	55	37	20	125	500	21970004505561	4003530097843
5.0 Ø dk = 9.7 mm	60	41	20	125	500	21970005006061	4003530040849
	70	52	20	125	500	21970005007061	4003530040856



Artículo bajo pedido





Tornillo universal, cabeza plana,

Ranura en cruz Z, rosca completa

4CUT, MULTI-Cabeza

Revestimiento sintético

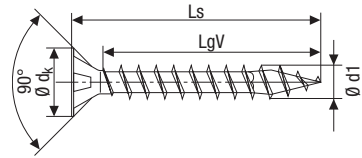

Acero inoxidable A2 1.4567

A2
AISI 304



Rosca- \varnothing d1	Dimensiones [mm]			Unidad de venta			N° SPAX	Cód. EAN
	Longitud total Ls	Longitud rosca completa LgV	Tamaño Huella Z	SPAX Box [uds]	Embalaje de cartón [uds]	Palé		
Embalaje pequeño								
3.0* $\varnothing d_k = 6.0$ mm	12	10	1	200	2,000	470,000	1087000300123	4003530014567
	16	14	1	200	2,000	470,000	1087000300163	4003530014574
	20	17	1	200	2,000	260,000	1087000300203	4003530014581
	25	21	1	200	2,000	260,000	1087000300253	4003530014598
	30	26	1	200	2,000	260,000	1087000300303	4003530014604
	40	36	1	200	2,000	224,000	1087000300403	4003530014628
3.5 $\varnothing d_k = 7.0$ mm	16	13	2	200	2,000	260,000	1087000350163	4003530014635
	20	16	2	200	2,000	260,000	1087000350203	4003530014642
	25	21	2	200	2,000	260,000	1087000350253	4003530014659
	30	25	2	200	2,000	260,000	1087000350303	4003530014666
	35	30	2	200	2,000	224,000	1087000350353	4003530014673
	40	35	2	200	2,000	224,000	1087000350403	4003530014680
4.0 $\varnothing d_k = 8.0$ mm	20	16	2	200	2,000	260,000	1087000400203	4003530014697
	25	21	2	200	2,000	260,000	1087000400253	4003530014703
	30	25	2	200	2,000	224,000	1087000400303	4003530014710
	35	30	2	200	2,000	224,000	1087000400353	4003530014727
	40	35	2	200	2,000	126,000	1087000400403	4003530014734
	45	40	2	200	2,000	126,000	1087000400453	4003530014741
	50	45	2	200	2,000	126,000	1087000400503	4003530014758
	60	50**	2	100	1,000	63,000	1087000400603	4003530040092
4.5 $\varnothing d_k = 8.8$ mm	25	20	2	200	2,000	224,000	1087000450253	4003530040108
	30	25	2	200	2,000	224,000	1087000450303	4003530014765
	35	30	2	200	2,000	126,000	1087000450353	4003530014772
	40	34	2	200	2,000	126,000	1087000450403	4003530014789
	45	39	2	200	2,000	126,000	1087000450453	4003530014796
	50	44	2	200	2,000	64,000	1087000450503	4003530014802
	60	54	2	100	1,000	63,000	1087000450603	4003530089169
	70	59**	2	100	1,000	63,000	1087000450703	4003530097102

*Modelo divergente.

**Modelo divergente. Rosca casi hasta la cabeza.



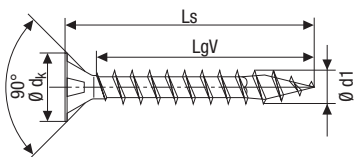

Tornillo universal, cabeza plana,

Ranura en cruz Z, rosca completa

4CUT, MULTI-Cabeza

Revestimiento sintético

Acero inoxidable A2 1.4567

A2
AISI 304

Rosca- \varnothing d1	Dimensiones [mm]			Unidad de venta			N° SPAX	Cód. EAN
	Longitud total Ls	Longitud rosca completa LgV	Tamaño Huella Z	SPAX Box [uds]	Embalaje de cartón [uds]	Palé		
Embalaje pequeño								
5.0 $\varnothing d_k = 9.7$ mm	30	25	2	200	2,000	224,000	1087000500303	4003530014819
	35	30	2	200	2,000	126,000	1087000500353	4003530014826
	40	35	2	200	2,000	126,000	1087000500403	4003530014833
	45	39	2	200	2,000	126,000	1087000500453	4003530014840
	50	44	2	200	2,000	64,000	1087000500503	4003530014857
	60	54	2	100	1,000	63,000	1087000500603	4003530014864
	70	61*	2	100	1,000	32,000	1087000500703	4003530014871
80	61*	2	100	1,000	32,000	1087000500803	4003530014888	
6.0 $\varnothing d_k = 11.6$ mm	40	34	3	200	2,000	64,000	1087000600403	4003530014901
	50	43	3	100	1,000	32,000	1087000600503	4003530014918
	60	53	3	100	1,000	32,000	1087000600603	4003530014925
	70	61*	3	100	1,000	32,000	1087000600703	4003530014932
	80	61*	3	100	1,000	32,000	1087000600803	4003530014949

*Modelo divergente. Rosca casi hasta la cabeza.





Tornillo universal, cabeza plana,

Ranura en cruz Z, rosca parcial

4CUT, MULTI-Cabeza

Revestimiento sintético

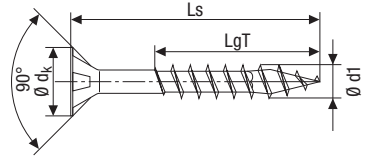

Acero inoxidable A2 1.4567

A2
AISI 304



Rosca- Ø d1	Dimensiones [mm]			Unidad de venta			N° SPAX	Cód. EAN
	Longitud total Ls	Longitud rosca parcial LgT	Tamaño Huella Z	SPAX Box [uds]	Embalaje de cartón [uds]	Palé		
Embalaje pequeño								
5.0 Ø dk = 9.7 mm	100	61	2	100	1,000	32,000	1087000501003	4003530109010
6.0 Ø dk = 11.6 mm	90	61	3	100	1,000	56,000	1087000600903	4003530014956
	100	61	3	100	1,000	32,000	1087000601003	4003530014963



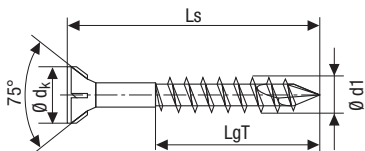

SPAX para listones de madera, cabeza plana,

Ranura en cruz Z, rosca parcial

Nervios fresadores, punta CUT

Revestimiento sintético

Acero inoxidable A2 1.4567

A2
AISI 304

Rosca- Ø d1	Dimensiones [mm]			Unidad de venta			SPAX No.	EAN code
	Longitud total Ls	Longitud rosca parcial LgT	Tamaño Huella Z	SPAX Box [uds]	Embalaje de cartón [uds]	Palé		
Embalaje pequeño								
3.5 Ø d _k = 6.1 mm	40	23	2	200	2,000	224,000	35703503401002	4003530168420





Tornillos para construcción de madera, cabeza plana,

T-Star plus, rosca completa

4CUT, MULTI-Cabeza

Revestimiento sintético

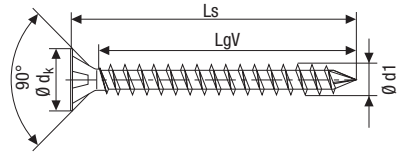

Acero inoxidable A4 1.4578

A4
AISI 316



Rosca- Ø	Dimensiones [mm]			Unidad de venta			N° SPAX	Cód. EAN
	Longitud total	Longitud rosca completa	Tamaño Huella	SPAX Box [uds]	Embalaje de cartón [uds]	Palé		
d1	Ls	LgV	T					
Embalaje estándar								
10.0 Ø dk = 18,6 mm	160		50	50	500	14,000	1208001001605	4003530182501
	200		50	50	500	12,000	1208001002005	4003530182303
	220	Rosca	50	50	500	12,000	1208001002205	4003530182310
	240	casi	50	50	-	4,800	1208001002405	4003530178689
	260	hasta la	50	50	-	4,800	1208001002605	4003530182327
	280	cabeza	50	50	-	4,800	1208001002805	4003530182334
	300		50	50	-	4,800	1208001003005	4003530182341
	350		50	50	-	3,600	1208001003505	4003530182228
400		50	50	-	3,600	1208001004005	4003530182235	

Artículo bajo pedido.



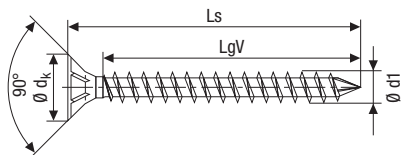

Tornillo para construcción en madera, cabeza plana,
T-Star plus, rosca completa
 Nervios fresadores, punta *CUT*
 Revestimiento sintético

Acero inoxidable A4 1.4578

A4
 AISI 316

Rosca- Ø	Dimensiones [mm]			SPAX Box [uds]	Unidad de venta		Nº SPAX	Cód. EAN
	Longitud total	Longitud rosca completa	Tamaño Huella		Palé	Embalaje de cartón [uds]		
d1	Ls	LgV	T					
Embalaje estándar								
12.0 Ø d _k = 18,6 mm	400	Rosca	50	25	–	1,800	1208001204005	4003530182242
	450	casi	50	25	–	1,500	1208001204505	4003530182259
	500	hasta la	50	25	–	1,500	1208001205005	4003530182266
	550	cabeza	50	20	–	960	1208001205505	4003530182495

Artículo bajo pedido.



Cabeza redonda	82-93
-----------------------	--------------

- WIROX

- Universal

- T-STAR *plus* 84-88

- Ranura en cruz Z 90-91

- ACERO INOXIDABLE A2	
------------------------------	--

- Universal

- T-STAR *plus* 92



CABEZA REDONDA



Gracias a su mayor superficie de contacto, el SPAX cabeza redonda permite que los herrajes metálicos se sujeten de forma firme y permanente.

Tanto en la cocina como en los dormitorios, el SPAX cabeza redonda puede ser utilizado fácil y rápidamente. La huella T-STAR plus garantiza un ajuste óptimo de la punta.



Tornillo universal, cabeza redonda,
T-Star plus, rosca completa

4CUT

Endurecido, revestimiento sintético

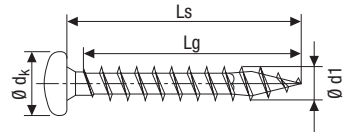

WIROX

A9J



Rosca Ø	Dimensiones [mm]			Unidad de venta			N° SPAX	Cód. EAN
	Longitud total	Longitud rosca	Tamaño Huella	SPAX Box [uds]	Embalaje de cartón [uds]	Palé		
d1	Ls	Lg	T					
Embalaje pequeño								
3.0* Ø dk = 6.0 mm	12	11	10	200	2,000	470,000	0201010300123	4003530165740
	16	15	10	200	2,000	470,000	0201010300163	4003530165764
	20	18	10	200	2,000	260,000	0201010300203	4003530170461
Embalaje estándar								
3.5 Ø dk = 7.0 mm	12	11	15	1,000	10,000	630,000	0201010350125	4003530165825
	15	13	15	1,000	10,000	630,000	0201010350155	4003530165849
	16	15	15	1,000	10,000	630,000	0201010350165	4003530113857
	20	18	15	1,000	10,000	630,000	0201010350205	4003530165887
	25	23	15	1,000	10,000	320,000	0201010350255	4003530165900
	30	27	15	1,000	10,000	320,000	0201010350305	4003530165924
	35	32	15	1,000	10,000	320,000	0201010350355	4003530162138

*Modelo divergente.



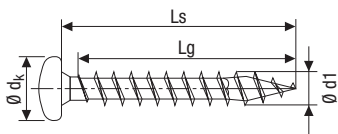

Tornillo universal, cabeza redonda,
T-Star plus, rosca completa

4CUT

Endurecido, revestimiento sintético



A9J

Rosca Ø	Dimensiones [mm]			Unidad de venta			N° SPAX.	Cód. EAN
	Longitud total	Longitud rosca	Tamaño Huella	SPAX Box [uds]	Embalaje de cartón [uds]	Palé		
d1	Ls	Lg	T					
Embalaje estándar								
4.0 Ø d _k = 8.0 mm	12	11	20	1,000	10,000	630,000	0201010400125	4003530165962
	15	13	20	1,000	10,000	630,000	0201010400155	4003530165986
	16	15	20	1,000	10,000	320,000	0201010400165	4003530108037
	20	18	20	1,000	10,000	320,000	0201010400205	4003530108044
	25	23	20	1,000	10,000	320,000	0201010400255	4003530160813
	30	27	20	1,000	10,000	280,000	0201010400305	4003530113871
	35	32	20	1,000	5,000	280,000	0201010400355	4003530113888
	40	37	20	500	5,000	160,000	0201010400405	4003530113895
50	47	20	500	5,000	140,000	0201010400505	4003530113901	
60	50*	20	500	5,000	140,000	0201010400605	4003530166099	
Embalaje pequeño								
4.0 Ø d _k = 8.0 mm	16	15	20	200	2,000	260,000	0201010400163	4003530165993
	20	18	20	200	2,000	260,000	0201010400203	4003530166013
	25	23	20	200	2,000	224,000	0201010400253	4003530166020
	30	27	20	200	2,000	224,000	0201010400303	4003530166037
	35	32	20	200	2,000	224,000	0201010400353	4003530166044
	40	37	20	200	2,000	126,000	0201010400403	4003530166051
	45	42	20	200	2,000	126,000	0201010400453	4003530166068
50	47	20	200	2,000	126,000	0201010400503	4003530166082	

*Modelo divergente. Rosca casi hasta la cabeza.





Tornillo universal, cabeza redonda,
T-Star plus, rosca completa

4CUT

Endurecido, revestimiento sintético

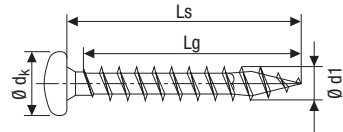

Rosca Ø	Dimensiones [mm]			Unidad de venta			N° SPAX	Cód. EAN
	Longitud total	Longitud rosca	Tamaño Huella	SPAX Box [uds]	Embalaje de cartón [uds]	Palé		
d1	Ls	Lg	T					
Embalaje estándar								
4.5 Ø dk = 9.0 mm	12	11	20	1,000	10,000	630,000	0201010450125	4003530166105
	15	13	20	1,000	10,000	320,000	0201010450155	4003530166112
	16	15	20	1,000	10,000	320,000	0201010450165	4003530165610
	20	17	20	1,000	10,000	320,000	0201010450205	4003530166150
	25	22	20	1,000	10,000	280,000	0201010450255	4003530166174
	30	27	20	500	5,000	160,000	0201010450305	4003530166198
	35	32	20	500	5,000	160,000	0201010450355	4003530161865
	40	37	20	500	5,000	160,000	0201010450405	4003530164705
	45	42	20	500	5,000	140,000	0201010450455	4003530164729
	50	47	20	500	5,000	140,000	0201010450505	4003530164736
60	57	20	500	5,000	140,000	0201010450605	4003530166242	
Embalaje pequeño								
4.5 Ø dk = 9.0 mm	20	17	20	200	2,000	260,000	0201010450203	4003530166143
	25	22	20	200	2,000	224,000	0201010450253	4003530166167
	30	27	20	200	2,000	224,000	0201010450303	4003530166181
	35	32	20	200	2,000	126,000	0201010450353	4003530166204
	40	37	20	200	2,000	126,000	0201010450403	4003530166211
	45	42	20	200	2,000	126,000	0201010450453	4003530166228
50	47	20	200	2,000	64,000	0201010450503	4003530166235	



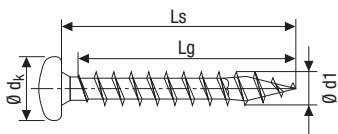

Tornillo universal, cabeza redonda,
T-Star plus, rosca completa

4CUT

Endurecido, revestimiento sintético



A9J

Rosca Ø d1	Dimensiones [mm]			Unidad de venta			SPAX No.	Cód. EAN
	Longitud total Ls	Longitud rosca Lg	Tamaño Huella T	SPAX Box [uds]	Embalaje de cartón [uds]	Palé		
Embalaje estándar								
5.0 Ø d _k = 9.9 mm	16	14	20	1,000	10,000	320,000	0201010500165	4003530166273
	20	17	20	1,000	10,000	320,000	0201010500205	4003530113918
	25	22	20	500	5,000	160,000	0201010500255	4003530113925
	30	27	20	500	5,000	160,000	0201010500305	4003530164699
	35	32	20	500	5,000	160,000	0201010500355	4003530113932
	40	37	20	500	5,000	140,000	0201010500405	4003530113949
	50	46	20	200	2,000	64,000	0201010500505	4003530113956
	60	56	20	200	2,000	64,000	0201010500605	4003530113963
	70	61*	20	200	2,000	64,000	0201010500705	4003530166389
80	61*	20	200	2,000	64,000	0201010500805	4003530148460	
90	61*	20	200	2,000	64,000	0201010500905	4003530166402	
Embalaje pequeño								
5.0 Ø d _k = 9.9 mm	20	17	20	200	2,000	224,000	0201010500203	4003530166297
	25	22	20	200	2,000	224,000	0201010500253	4003530166303
	30	27	20	200	2,000	126,000	0201010500303	4003530166310
	35	32	20	200	2,000	126,000	0201010500353	4003530166327
	40	37	20	200	2,000	126,000	0201010500403	4003530166334
	50	46	20	100	1,000	63,000	0201010500503	4003530166358
	60	56	20	100	1,000	63,000	0201010500603	4003530166365
	70	61*	20	100	1,000	32,000	0201010500703	4003530166372
	80	61*	20	100	1,000	32,000	0201010500803	4003530166396

*Modelo divergente. Rosca casi hasta la cabeza.





Tornillo universal, cabeza redonda,
T-Star plus, rosca completa

4CUT

Endurecido, revestimiento sintético

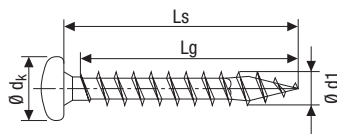

WIROX

A9J



Rosca \emptyset	Dimensiones [mm]			Unidad de venta			N° SPAX	Cód. EAN
	Longitud total	Longitud rosca	Tamaño Huella	SPAX Box [uds]	Embalaje de cartón [uds]	Palé		
d1	Ls	Lg	T					
Embalaje estándar								
6.0 $\emptyset dk = 11.6 mm$	20	17	30	500	5,000	160,000	0201010600205	4003530166419
	25	22	30	500	5,000	160,000	0201010600255	4003530166426
	30	27	30	500	2,500	140,000	0201010600305	4003530166433
	35	32	30	500	2,500	140,000	0201010600355	4003530127885
	40	37	30	500	2,500	140,000	0201010600405	4003530166457
	50	46	30	200	2,000	64,000	0201010600505	4003530165085
	60	56	30	200	2,000	56,000	0201010600605	4003530113970
	70	61*	30	200	2,000	56,000	0201010600705	4003530113987
	80	61*	30	200	1,000	56,000	0201010600805	4003530166488
	90	61*	30	200	1,000	56,000	0201010600905	4003530166495
100	61*	30	100	1,000	32,000	0201010601005	4003530166501	
Embalaje pequeño								
6.0 $\emptyset dk = 11.6 mm$	40	37	30	200	2,000	64,000	0201010600403	4003530166440
	50	46	30	100	1,000	32,000	0201010600503	4003530166471

*Modelo divergente. Rosca casi hasta la cabeza.





Tornillo universal, cabeza redonda,

Ranura en cruz Z, rosca completa

4CUT

Endurecido, revestimiento sintético

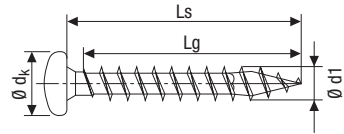

WIROX

A9J



Rosca Ø	Dimensiones [mm]			Unidad de venta			N° SPAX	Cód. EAN
	Longitud total	Longitud rosca	Tamaño Huella	SPAX Box [uds]	Embalaje de cartón [uds]	Palé		
d1	Ls	Lg	Z					
Embalaje estándar								
3.0* Ø dk = 6.0 mm	10	8	1	1,000	10,000	1,120,000	0231010300105	4003530014970
	12	11	1	1,000	10,000	1,120,000	0231010300125	4003530014987
	15	13	1	1,000	10,000	1,120,000	0231010300155	4003530015007
	16	15	1	1,000	10,000	630,000	0231010300165	4003530015014
	20	18	1	1,000	10,000	630,000	0231010300205	4003530015038
	25	23	1	1,000	10,000	630,000	0231010300255	4003530015045
	30	28	1	1,000	10,000	320,000	0231010300305	4003530015052
3.5 Ø dk = 7.0 mm	12	11	2	1,000	10,000	630,000	0231010350125	4003530015069
	15	13	2	1,000	10,000	630,000	0231010350155	4003530015083
	16	15	2	1,000	10,000	630,000	0231010350165	4003530015090
	20	18	2	1,000	10,000	630,000	0231010350205	4003530015106
	25	23	2	1,000	10,000	320,000	0231010350255	4003530015113
	30	27	2	1,000	10,000	320,000	0231010350305	4003530015120
	35	32	2	1,000	10,000	320,000	0231010350355	4003530015137
40	37	2	1,000	10,000	280,000	0231010350405	4003530015144	
4.0 Ø dk = 8.0 mm	12	11	2	1,000	10,000	630,000	0231010400125	4003530015151
	15	13	2	1,000	10,000	630,000	0231010400155	4003530015175
	16	15	2	1,000	10,000	320,000	0231010400165	4003530015182
	20	18	2	1,000	10,000	320,000	0231010400205	4003530015212
	25	23	2	1,000	10,000	320,000	0231010400255	4003530015229
	30	27	2	1,000	10,000	280,000	0231010400305	4003530015236
	35	32	2	1,000	5,000	280,000	0231010400355	4003530015243
	40	37	2	500	5,000	160,000	0231010400405	4003530015250
	45	42	2	500	5,000	160,000	0231010400455	4003530015267
50	47	2	500	5,000	140,000	0231010400505	4003530015274	
60	50**	2	500	5,000	140,000	0231010400605	4003530015281	
4.5 Ø dk = 9.0 mm	12	11	2	1,000	10,000	630,000	0231010450125	4003530015298
	15	13	2	1,000	10,000	320,000	0231010450155	4003530015304
	16	15	2	1,000	10,000	320,000	0231010450165	4003530015311

*Modelo divergente.

**Modelo divergente. Rosca casi hasta la cabeza.



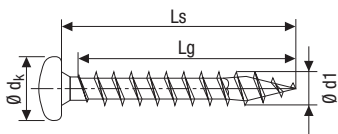

Tornillo universal, cabeza redonda,
T-Star plus, rosca completa

4CUT

Endurecido, revestimiento sintético



A9J

Rosca \emptyset	Dimensiones [mm]			Unidad de venta			N° SPAX	Cód. EAN
	Longitud total	Longitud rosca	Tamaño Huella	SPAX Box [uds]	Embalaje de cartón [uds]	Palé		
d1	Ls	Lg	Z					
Embalaje estándar								
4.5 $\emptyset dk = 9.0 \text{ mm}$	20	17	2	1,000	10,000	320,000	0231010450205	4003530015335
	25	22	2	1,000	10,000	280,000	0231010450255	4003530015342
	30	27	2	500	5,000	160,000	0231010450305	4003530015359
	35	32	2	500	5,000	160,000	0231010450355	4003530015366
	40	37	2	500	5,000	160,000	0231010450405	4003530015373
	45	42	2	500	5,000	140,000	0231010450455	4003530015380
	50	47	2	500	5,000	140,000	0231010450505	4003530015397
	60	57	2	500	2,500	140,000	0231010450605	4003530103353
5.0 $\emptyset dk = 9.9 \text{ mm}$	15	12	2	1,000	10,000	320,000	0231010500155	4003530039478
	16	14	2	1,000	10,000	320,000	0231010500165	4003530015403
	20	17	2	1,000	10,000	320,000	0231010500205	4003530015427
	25	22	2	500	5,000	160,000	0231010500255	4003530015434
	30	27	2	500	5,000	160,000	0231010500305	4003530015441
	35	32	2	500	5,000	160,000	0231010500355	4003530015458
	40	37	2	500	5,000	140,000	0231010500405	4003530016059
	45	41	2	200	2,000	64,000	0231010500455	4003530015472
	50	46	2	200	2,000	64,000	0231010500505	4003530015489
	60	56	2	200	2,000	64,000	0231010500605	4003530015496
	70	61*	2	200	2,000	64,000	0231010500705	4003530015502
	80	61*	2	200	2,000	64,000	0231010500805	4003530015519
	90	61*	2	200	2,000	64,000	0231010500905	4003530015526
6.0 $\emptyset dk = 11.6 \text{ mm}$	25	22	3	500	5,000	160,000	0231010600255	4003530103421
	30	27	3	500	2,500	140,000	0231010600305	4003530015533
	35	32	3	500	2,500	140,000	0231010600355	4003530015540
	40	37	3	500	2,500	140,000	0231010600405	4003530015557
	50	46	3	200	2,000	64,000	0231010600505	4003530015571
	60	56	3	200	2,000	56,000	0231010600605	4003530015588
	70	61*	3	200	2,000	56,000	0231010600705	4003530015595
	80	61*	3	200	1,000	56,000	0231010600805	4003530015601
	90	61*	3	200	1,000	56,000	0231010600905	4003530015618

*Modelo divergente. Rosca casi hasta la cabeza.





Tornillo universal, cabeza redonda,
T-Star plus, rosca completa

4CUT

Endurecido, revestimiento sintético

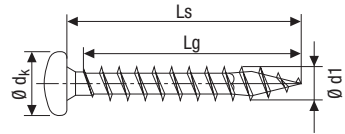

Acero inoxidable A2 1.4567

A2
AISI 304



Rosca Ø	Dimensiones [mm]			Unidad de venta			N° SPAX	Cód. EAN
	Longitud total	Longitud rosca completa	Tamaño Huella	SPAX Box [uds]	Embalaje de cartón [uds]	Palé		
d1	Ls	Lg	Z					
Embalaje pequeño								
3.0* Ø dk = 6.0 mm	20	18	10	200	2,000	260,000	0207000300203	4003530175183
	30	28	10	200	2,000	260,000	0207000300303	4003530175190
3.5 Ø dk = 7.0 mm	20	18	15	200	2,000	260,000	0207000350203	4003530175206
	30	27	15	200	2,000	260,000	0207000350303	4003530175213
4.0 Ø dk = 8.0 mm	20	18	20	200	2,000	260,000	0207000400203	4003530175220
	25	23	20	200	2,000	260,000	0207000400253	4003530175237
	30	27	20	200	2,000	224,000	0207000400303	4003530175244
	35	32	20	200	2,000	126,000	0207000400353	4003530175251
	40	37	20	200	2,000	126,000	0207000400403	4003530175268
	45	42	20	200	2,000	126,000	0207000400453	4003530175275
5.0 Ø dk = 9.9 mm	50	47	20	200	2,000	126,000	0207000400503	4003530175282
	25	22	20	200	2,000	224,000	0207000500253	4003530175299
	30	27	20	200	2,000	224,000	0207000500303	4003530175305
	40	37	20	200	2,000	126,000	0207000500403	4003530175312
	50	46	20	100	1,000	63,000	0207000500503	4003530175329

*Modelo divergente.



Cabeza gota de sebo	94-101
- WIROX	
• Universal	
Ranura en cruz Z	96
<hr/>	
- NIQUELADO	
• Universal	
- Ranura en cruz Z	97
<hr/>	
- ACERO INOXIDABLE A2	
• Universal	
- T-STAR <i>plus</i>	98
• Fachada exterior	
- T-STAR <i>plus</i>	99-101
• Tornillo de sellado	
- T-Star <i>plus</i>	101

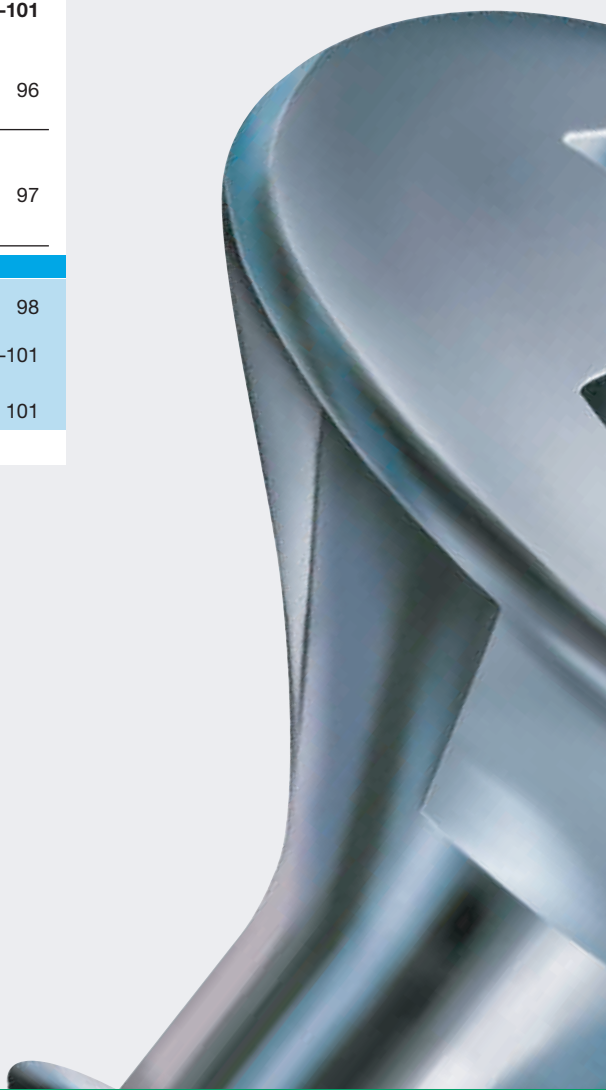

CABEZA GOTA DE SEBO



El tornillo cabeza de sebo puede ser encajado en la madera.

El ligero arco de la cabeza del tornillo visible después del atornillado agrega un toque estético adicional.

Es por eso que a menudo se usan tornillos de cabeza gota de sebo para uniones visibles, como en zócalos.



Tornillo universal, cabeza gota de sebo

Ranura en cruz Z, rosca completa

4CUT, MULTI-Cabeza

Endurecido, revestimiento sintético

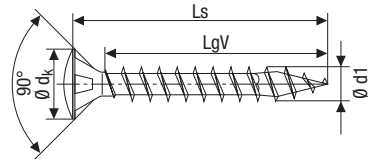

WIROX

A9J



Rosca- Ø	Dimensiones [mm]			Unidad de venta			N° SPAX	Cód. EAN
	Longitud total Ls	Longitud rosca completa LgV	Tamaño Huella Z	SPAX Box [uds]	Embalaje de cartón [uds]	Palé		
d1	Ls	LgV	Z					
<i>Embalaje estándar</i>								
3.5 Ø dk = 7.0 mm	15	11	2	1,000	10,000	630,000	0241010350155	4003530016295
	16	13	2	1,000	10,000	630,000	0241010350165	4003530016301
	20	16	2	1,000	10,000	630,000	0241010350205	4003530016325
	25	21	2	1,000	10,000	320,000	0241010350255	4003530016332
	30	25	2	1,000	10,000	320,000	0241010350305	4003530016349
4.0 Ø dk = 8.0 mm	16	13	2	1,000	10,000	630,000	0241010400165	4003530016387
	20	16	2	1,000	10,000	320,000	0241010400205	4003530016400
	25	21	2	1,000	10,000	320,000	0241010400255	4003530016417
	30	25	2	1,000	10,000	320,000	0241010400305	4003530016424
	35	30	2	1,000	10,000	280,000	0241010400355	4003530016431



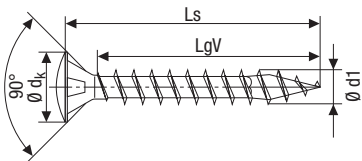

Tornillo universal, cabeza gota de sebo,

Ranura en cruz Z, rosca completa

4CUT, MULTI-Cabeza

Endurecido, revestimiento sintético

Niquelado

E1J

Rosca- Ø d1	Dimensiones [mm]			Unidad de venta			N° SPAX	Cód. EAN
	Longitud total Ls	Longitud rosca completa LgV	Tamaño Huella Z	SPAX Box [uds]	Embalaje de cartón [uds]	Palé		
<i>Embalaje estándar</i>								
3.5 Ø dk = 7.0 mm	16	13	2	1,000	10,000	630,000	0241030350165	4003530016813
	20	16	2	1,000	10,000	630,000	0241030350205	4003530016820
	25	21	2	1,000	10,000	320,000	0241030350255	4003530016837
	30	25	2	1,000	10,000	320,000	0241030350305	4003530016844
4.0 Ø dk = 8.0 mm	16	13	2	1,000	10,000	630,000	0241030400165	4003530105883
	20	16	2	1,000	10,000	320,000	0241030400205	4003530039553
	25	21	2	1,000	10,000	320,000	0241030400255	4003530039560
	30	25	2	1,000	10,000	320,000	0241030400305	4003530039577
	35	30	2	1,000	10,000	280,000	0241030400355	4003530039584





Tornillo universal, cabeza gota de sebo,

T-Star plus, rosca completa

4CUT, MULTI-Cabeza

Endurecido, revestimiento sintético

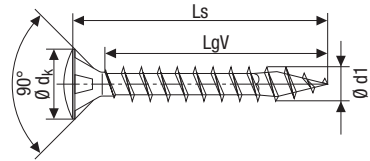

Acero inoxidable A2 1.4567

A2
AISI 304



Rosca- \emptyset d_1	Dimensiones [mm]			Unidad de venta			N° SPAX	Cód. EAN
	Longitud total L_s	Longitud rosca completa L_{gV}	Tamaño Huella T	SPAX Box [uds]	Embalaje de cartón [uds]	Palé		
Embalaje pequeño								
3.0* $\emptyset d_k =$ 6.0 mm	20	17	10	200	2,000	260,000	0627000300203	4003530167843
	25	21	10	200	2,000	260,000	0627000300253	4003530167850
3.5 $\emptyset d_k =$ 7.0 mm	16	13	15	200	2,000	260,000	0627000350163	4003530167874
	20	16	15	200	2,000	260,000	0627000350203	4003530167881
	30	25	15	200	2,000	260,000	0627000350303	4003530167904
4.0 $\emptyset d_k =$ 8.0 mm	30	25	20	200	2,000	224,000	0627000400303	4003530167911
	40	35	20	200	2,000	126,000	0627000400403	4003530167935
	45	40	20	200	2,000	126,000	0627000400453	4003530167942
4.5 $\emptyset d_k =$ 8.8 mm	50	44	20	200	2,000	64,000	0627000450503	4003530167973

*Modelo divergente.



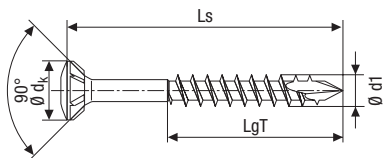

**Tornillo para fachada, cabeza gota de sebo,
T-Star plus, rosca parcial**

Nervios fresadores, punta CUT

Revestimiento sintético

Acero inoxidable A2 1.4567

A2
AISI 304

Rosca- Ø d1	Dimensiones [mm]			Unidad de venta			N° SPAX	Cód. EAN
	Longitud total Ls	Longitud rosca parcial LgT	Tamaño Huella T	SPAX Box [uds]	Embalaje de cartón [uds]	Palé		
Embalaje pequeño								
4.5 Ø d _k = 8.8 mm	35	25	20	200	2,000	224,000	25170004503521	4003530184055
	40	25	20	200	2,000	126,000	25170004504021	4003530184062
	45	30	20	200	2,000	126,000	25170004504521	4003530184079
	50	32	20	200	2,000	64,000	25170004505021	4003530184086
	60	37	20	100	1,000	63,000	25170004506021	4003530184093
	70	42	20	100	1,000	32,000	25170004507021	4003530184109
	80	47	20	100	1,000	32,000	25170004508021	4003530184116
5.0 Ø d _k = 9.7 mm	60	37	20	100	1,000	63,000	25170005006021	4003530184123
	70	41	20	100	1,000	32,000	25170005007021	4003530184130
	80	46	20	100	1,000	32,000	25170005008021	4003530184147
	90	61	20	100	1,000	32,000	25170005009021	4003530184154
	100	61	20	100	1,000	32,000	25170005010021	4003530184215





Tornillo para fachada, cabeza gota de sebo,

T-Star plus, rosca de fijación

4CUT, nervios fresadores y cabeza reducida (Ø 8 mm)

Revestimiento sintético

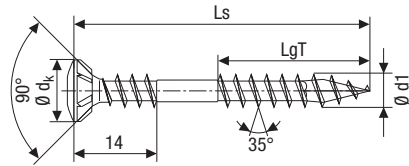

Acero inoxidable A2 1.4567

A2
AISI 304

Rosca- Ø d1	Dimensiones [mm]			Unidad de venta			Nº SPAX	Cód. EAN
	Longitud total Ls	Longitud rosca parcial LgT	Tamaño Huella T	SPAX Box [uds]	Embalaje de cartón [uds]	Palé		
Embalaje pequeño								
4.5 Ø dk = 8.0 mm	50	21	20	200	2,000	64,000	25470004505022	4003530183881
	60	26	20	100	1,000	63,000	25470004506022	4003530183904
	70	31	20	100	1,000	32,000	25470004507022	4003530184048



Tornillo para fachada, cabeza gota de sebo,

T-Star plus, rosca de fijación

4CUT, nervios fresadores y cabeza reducida (Ø 8 mm)

Revestimiento sintético

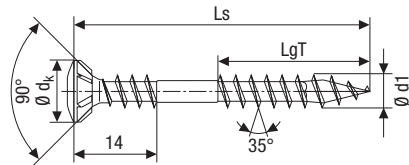

Acero inoxidable A2 1.4567

A2
AISI 304

A2
antique

Rosca- Ø d1	Dimensiones [mm]			Unidad de venta			Nº SPAX	Cód. EAN
	Longitud total Ls	Longitud rosca parcial LgT	Tamaño Huella T	SPAX Box [uds]	Embalaje de cartón [uds]	Palé		
Embalaje pequeño								
4.5 Ø dk = 8.0 mm	50	21	20	200	2,000	64,000	25479004505022	4003530183935
	60	26	20	100	1,000	63,000	25479004506022	4003530183959



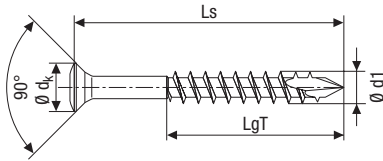

Tornillo para fachada, cabeza gota de sebo, cabeza muy pequeña, T-STAR plus, rosca parcial

punta CUT

Revestimiento sintético

Acero inoxidable A2 1.4567

A2
AISI 304

Rosca- \varnothing d_1	Dimensiones [mm]			Unidad de venta			N° SPAX	Cód. EAN
	Longitud total L_s	Longitud rosca parcial L_gT	Tamaño Huella T	SPAX Box [uds]	Embalaje de cartón [uds]	Palé		
Embalaje pequeño								
4.0 $\varnothing d_k =$ 6.0 mm	40	24	15	100	1,000	112,000	0467000400403	4003530184314
	45	29	15	100	1,000	112,000	0467000400453	4003530184321
	60	29	15	100	1,000	63,000	0467000400603	4003530261282
4.5 $\varnothing d_k =$ 7.0 mm	70	42	15	100	1,000	32,000	0467000450703	4003530184338
5.0 $\varnothing d_k =$ 8.0 mm	100	61	20	100	1,000	32,000	0467000501003	4003530184345



NUEVO

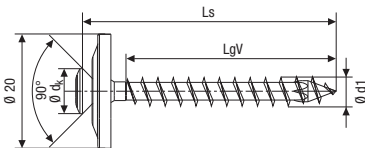

Tornillo de sellado, cabeza arandela y gota de sebo T-Star plus, rosca completa

4CUT

Arandela de sellado de acero inoxidable A2 con sellado EPDM

Acero inoxidable A2 1.4567

A2
AISI 304

Rosca- \varnothing d_1	Dimensiones [mm]			Unidad de venta			N° SPAX	Cód. EAN
	Longitud total L_s	Longitud rosca completa L_gV	Tamaño Huella T	SPAX Box [uds]	Embalaje de cartón [uds]	Palé		
Embalaje estándar								
4.5 $\varnothing d_k =$ 8.0 mm	25	18	20	75	375	90,000	4577000450257	4003530266812
	35	28	20	60	300	72,000	4577000450357	4003530266836
	45	37	20	80	240	53,760	4577000450456	4003530266850
	55	47	20	70	210	47,040	4577000450556	4003530266874



NUEVO



Tornillo de unión	102-109
- WIROX Cabeza arandela	
• Universal	
- Ranura en cruz Z	104
<hr/>	
- WIROX Cabeza arandela	
• Universal	
- T-STAR <i>plus</i>	105
<hr/>	
- WIROX Cabeza arandela	
• Tornillo de ajuste	
- T-STAR <i>plus</i>	106
<hr/>	
- WIROX Cabeza arandela	
• Construcción en madera	
- T-STAR <i>plus</i>	107-108
<hr/>	
- ACERO INOXIDABLE A2 CABEZA ARANDELA	
• Construcción en madera	
- T-STAR <i>plus</i>	109



TORNILLO DE UNIÓN

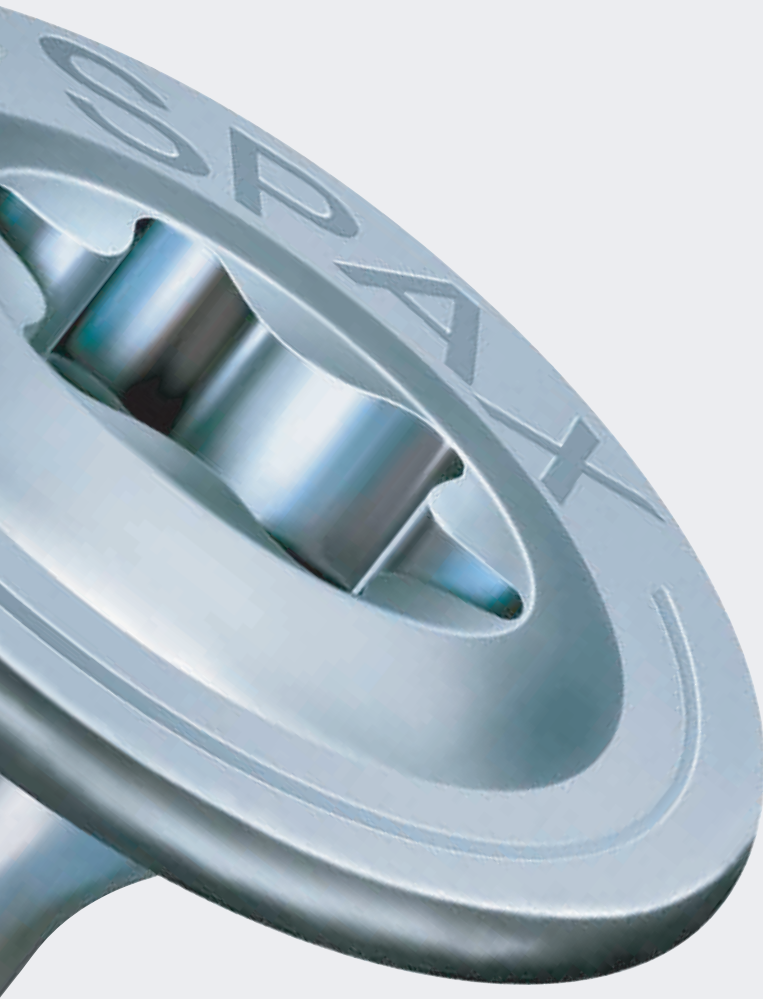

El SPAX tornillo de unión con cabeza arandela garantiza mayores fuerzas de apriete de la cabeza para una sujeción segura de maderas incluso deformadas. El atornillado de las piezas de acero y la chapa metálica a la madera también es posible sin taladrar previamente.

La cabeza con arandela generalmente garantiza un mejor efecto de sujeción de la cabeza sujetando láminas metálicas delgadas. El tornillo de cabeza de unión es especialmente adecuado para el montaje de muebles.



Tornillo universal, cabeza arandela,

Ranura en cruz Z, rosca completa

4CUT

Endurecido, revestimiento sintético

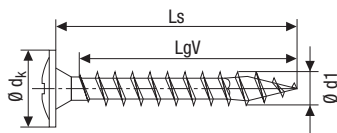

A9J



Rosca- Ø d1	Dimensiones [mm]			Unidad de venta			N° SPAX	Cód. EAN
	Longitud total Ls	Longitud rosca completa LgV	Tamaño Huella Z	SPAX Box [uds]	Embalaje de cartón [uds]	Palé		
Embalaje estándar								
3.5 Ø d _K = 8.6 mm	17	15	2	3,000	–	912,000	0281010350172	4003530109799
	20	18	2	3,000	–	912,000	0281010350202	4003530109713
	25	23	2	2,000	–	608,000	0281010350252	4003530109720
	30	27	2	3,000	–	441,000	0281010350302	4003530109737
	35	32	2	2,000	–	294,000	0281010350352	4003530109744
4.0 Ø d _K = 9.6 mm	13	11	2	3,000	–	456,000	0281010400132	4003530109751
	17	15	2	2,000	–	456,000	0281010400172	4003530107153
	20	18	2	2,000	–	456,000	0281010400202	4003530109768
	25	23	2	3,000	–	441,000	0281010400252	4003530107160
	30	27	2	2,000	–	294,000	0281010400302	4003530107177
	35	32	2	2,000	–	294,000	0281010400352	4003530092046
	40	37	2	1,500	–	220,500	0281010400402	4003530097348
4.5 Ø d _K = 10.6 mm	45	42	2	1,000	–	147,000	0281010400452	4003530107184
	20	17	2	3,000	–	441,000	0281010450202	4003530092053
	25	22	2	2,000	–	294,000	0281010450252	4003530092060
	30	27	2	2,000	–	294,000	0281010450302	4003530092077
	35	32	2	1,500	–	220,500	0281010450352	4003530097331
	40	37	2	1,000	–	147,000	0281010450402	4003530092084
5.0 Ø d _K = 11.6 mm	45	42	2	1,000	–	147,000	0281010450452	4003530092091
	50	47	2	1,000	–	147,000	0281010450502	4003530092107
	20	17	2	2,000	–	294,000	0281010500202	4003530092114
	25	22	2	1,000	–	304,000	0281010500252	4003530092121
	30	27	2	1,000	–	147,000	0281010500302	4003530092206
	35	32	2	1,000	–	147,000	0281010500352	4003530092138
	40	37	2	1,000	–	147,000	0281010500402	4003530092145
	45	41	2	1,000	–	147,000	0281010500452	4003530092152
50	46	2	1,000	–	147,000	0281010500502	4003530092169	
60	56	2	500	–	73,500	0281010500602	4003530092176	



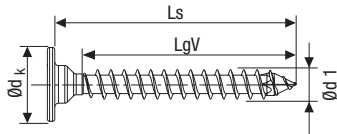

Tornillo universal, cabeza arandela extraplana,
T-STAR *plus*, rosca completa

4CUT

Endurecido, revestimiento sintético

Rosca- Ø d1	Dimensiones [mm]			Unidad de venta			N° SPAX	Cód. EAN
	Longitud total Ls	Longitud rosca parcial LgV	Tamaño Huella T	SPAX Box [uds]	Embalaje de cartón [uds]	Palé		
Embalaje pequeño								
3.0* Ø dk = 7.9 mm	20	18	10	300	3,000	336,000	0151010300203	4003530258565
	25	23	10	300	3,000	336,000	0151010300253	4003530258558
	30	28	10	300	3,000	336,000	0151010300303	4003530258541
3.5 Ø dk = 8.7 mm	25	23	20	300	3,000	336,000	0151010350253	4003530258107
	30	27	20	300	3,000	336,000	0151010350303	4003530258114
	40**	37	20	200	2,000	224,000	21510103504051	4003530259012
4.0 Ø dk = 10.0 mm	16	15	20	300	3,000	336,000	0151010400163	4003530258015
	20	18	20	300	3,000	336,000	0151010400203	4003530258008
	25	23	20	300	3,000	336,000	0151010400253	4003530257995

*Modelo divergente.

**con punta CUT para MDF.

NUEVO

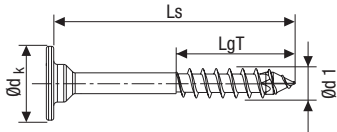

Tornillo universal, cabeza arandela extraplana,
T-STAR *plus*, rosca completa

4CUT

Endurecido, revestimiento sintético

Niquelado

E1J

Rosca- Ø d1	Dimensiones [mm]			Unidad de venta			N° SPAX	Cód. EAN
	Longitud total Ls	Longitud rosca parcial LgT	Tamaño Huella T	SPAX Box [uds]	Embalaje de cartón [uds]	Palé		
Embalaje pequeño								
4.0 Ø dk = 10.0 mm	30	16	20	200	2,000	224,000	0681030400303	4003530257841
	34	16	20	200	2,000	224,000	0681030400343	4003530257858

Longitud de eje adaptada a grosores de pared de 16 mm y 19 mm para la unión de armarios.

NUEVO





Tornillo de ajuste, cabeza plana,
T-STAR plus, rosca parcial, ranuras de retención

4CUT

Endurecido, revestimiento sintético

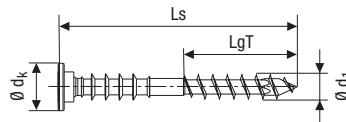

Rosca- Ø d1	Dimensiones [mm]		Tamaño Huella T	Unidad de venta			N° SPAX	Cód. EAN
	Longitud total Ls	Longitud rosca parcial LgT		SPAX Box [uds]	Embalaje de cartón [uds]	Palé		
Embalaje estándar								
6.0 Ø dk = 12.0 mm	100	61	30	100	1,000	32,000	0161010601005	4003530260568
	110	68	30	100	1,000	32,000	0161010601105	4003530260575
	120	68	30	100	1,000	28,000	0161010601205	4003530260582
	130	68	30	100	1,000	28,000	0161010601305	4003530260599
	145	68	30	100	1,000	28,000	0161010601455	4003530260605
160	68	30	100	1,000	28,000	0161010601605	4003530260612	
Embalaje pequeño								
6.0 Ø dk = 12.0 mm	60	32	30	100	1,000	32,000	0161010600603	4003530260520
	70	37	30	100	1,000	32,000	0161010600703	4003530260537
	80	46	30	100	1,000	32,000	0161010600803	4003530260544
	90	61	30	100	1,000	32,000	0161010600903	4003530260551

Disponible a partir de marzo 2020.

NUEVO



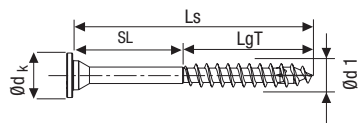

Tornillo universal, cabeza arandela extraplana

T-STAR plus, rosca parcial

4CUT

Endurecido, revestimiento sintético



A9J

Rosca- Ø d1	Dimensiones [mm]			Unidad de venta			Nº SPAX	Cód. EAN
	Longitud total Ls	Longitud rosca parcial LgT	Tamaño Huella T	SPAX Box [uds]	Embalaje de cartón [uds]	Palé		
Embalaje estándar								
5.0	77	46	20	150	1,500	48,000	0251010500775	4003530253430
Ø d _k = 11.6 mm	87	46	20	150	1,500	48,000	0251010500875	4003530253447
	107	46	20	150	1,500	48,000	0251010501075	4003530253423

5.0 x 77 con 31 mm de eje SL
5.0 x 87 con 41 mm de eje SL
5.0 x 107 con 61 mm de eje SL

NUEVO

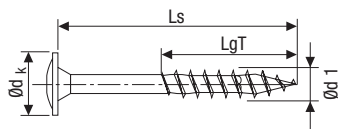

Tornillo construcción en madera, cabeza arandela,

T-STAR plus, rosca parcial/completa

4CUT

Endurecido, revestimiento sintético



A9J

Rosca- Ø d1	Dimensiones [mm]			Unidad de venta			Nº SPAX	Cód. EAN	
	Longitud total Ls	Longitud rosca Lg	Tamaño Huella T	SPAX Box [uds]	Embalaje de cartón [uds]	Palé			
Embalaje estándar									
6.0 Ø d _k = 13.6 mm	40	37	■	30	200	2,000	64,000	0251010600405	4003530257490
	60	56	■	30	200	2,000	56,000	0251010600605	4003530248351
	80	61	■	30	100	1,000	28,000	0251010600805	4003530245572
	100	61	□	30	100	1,000	32,000	0251010601005	4003530245589
	120	68	□	30	100	1,000	28,000	0251010601205	4003530245596
	140	68	□	30	100	1,000	28,000	0251010601405	4003530245602
	160	65	□	30	100	1,000	28,000	0251010601605	4003530245619
	180	65	□	30	100	1,000	28,000	0251010601805	4003530245626
	200	65	□	30	50	500	12,000	0251010602005	4003530248474
	220	65	□	30	50	500	12,000	0251010602205	4003530250002
	250	65	□	30	50	-	4,800	0251010602505	4003530248511
	280	65	□	30	50	-	4,800	0251010602805	4003530253133
300	65	□	30	50	-	4,800	0251010603005	4003530248528	

■ T-STAR plus, rosca completa □ T-STAR plus, rosca parcial

NUEVO





Tornillo para construcción en madera, cabeza arandela, T-STAR plus, rosca parcial/completa

4CUT

Endurecido, revestimiento sintético

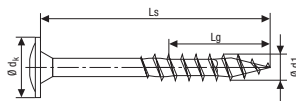

Rosca Ø	Dimensiones [mm]			Tamaño Huella T	Unidad de venta			N° SPAX	Cód. EAN
	Longitud total Ls	Longitud rosca Lg			SPAX Box [uds]	Embalaje de cartón [uds]	Palé		
d1	Ls	Lg		T					
Embalaje estándar									
8.0 Ø dk = 20 mm	50*	46	■	40	50	500	16,000	0251720800505	4003530182358
	80	70	■	40	50	500	14,000	0251010800805	4003530165184
	100	80	■	40	50	500	14,000	0251010801005	4003530245640
	120	80	■	40	50	500	14,000	0251010801205	4003530245657
	140	80	□	40	50	500	14,000	0251010801405	4003530245664
	160	80	□	40	50	500	14,000	0251010801605	4003530245671
	180	80	□	40	50	500	14,000	0251010801805	4003530245688
	200	80	□	40	50	500	12,000	0251010802005	4003530245695
	220	80	□	40	50	500	12,000	0251010802205	4003530245701
	240	80	□	40	50	-	4,800	0251010802405	4003530245718
	260	80	□	40	50	-	4,800	0251010802605	4003530245725
	280	80	□	40	50	-	4,800	0251010802805	4003530245732
	300	80	□	40	50	-	4,800	0251010803005	4003530245749
	320	80	□	40	50	-	3,600	0251010803205	4003530245756
	340	80	□	40	50	-	3,600	0251010803405	4003530245763
	360	80	□	40	50	-	3,600	0251010803605	4003530245770
	380	80	□	40	50	-	3,600	0251010803805	4003530245787
	400	80	□	40	50	-	3,600	0251010804005	4003530245794
450	80	□	40	25	-	1,500	0251010804505	4003530245800	
500	80	□	40	25	-	1,500	0251010805005	4003530257254	
550	80	□	40	25	-	1,200	0251010805505	4003530257261	
10.0 Ø dk = 25 mm	80	70	■	50	50	500	14,000	0251011000805	4003530245817
	100	80	■	50	50	500	12,000	0251011001005	4003530245824
	120	80	■	50	50	500	12,000	0251011001205	4003530245831
	140	80	□	50	50	500	12,000	0251011001405	4003530245848
	160	80	□	50	25	250	6,000	0251011001605	4003530165207
	180	80	□	50	25	250	6,000	0251011001805	4003530245862
	200	80	□	50	25	250	6,000	0251011002005	4003530245879
	220	80	□	50	25	250	6,000	0251011002205	4003530165214
	240	80	□	50	25	-	2,400	0251011002405	4003530245893
	260	80	□	50	25	-	2,400	0251011002605	4003530245909
	280	80	□	50	25	-	2,400	0251011002805	4003530245916
	300	80	□	50	25	-	2,400	0251011003005	4003530245923
	320	80	□	50	25	-	1,800	0251011003205	4003530245930
	340	80	□	50	25	-	1,800	0251011003405	4003530245947
	360	80	□	50	25	-	1,800	0251011003605	4003530245954
	380	80	□	50	25	-	1,800	0251011003805	4003530245961
	400	80	□	50	25	-	1,800	0251011004005	4003530245978
	450	80	□	50	25	-	1,500	0251011004505	4003530245985

■ T-STAR plus, rosca completa □ T-STAR plus, rosca parcial

*Acabado diferente: P5J

NUEVO



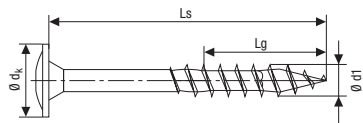

Tornillo para construcción en madera, cabeza arandela,
T-STAR plus, rosca parcial/completa

4CUT

Revestimiento sintético

Acero inoxidable A2 1.4567

A2
AISI 304

Rosca \emptyset	Dimensiones [mm]			Tamaño Huella T	Unidad de venta			N° SPAX	Cód. EAN
	Longitud total	Longitud rosca			SPAX Box [uds]	Embalaje de cartón [uds]	Palé		
d1	Ls	Lg							
Embalaje estándar									
6.0 $\emptyset d_k =$ 13.6 mm	60	56	■	30	100	1,000	32,000	0257000600605	4003530183027
	80	61	■	30	100	1,000	28,000	0257000600805	4003530183034
	100	61	□	30	100	1,000	32,000	0257000601005	4003530183041
	120	68	□	30	100	1,000	28,000	0257000601205	4003530183058
	140	68	□	30	100	1,000	28,000	0257000601405	4003530183065
8.0 $\emptyset d_k =$ 20 mm	50	46	■	40	50	500	14,000	0257000800505	4003530182815
	60	56	■	40	50	500	14,000	0257000800605	4003530182839
	80	70	■	40	50	500	14,000	0257000800805	4003530176760
	100	80	■	40	50	500	14,000	0257000801005	4003530177880
	120	80	■	40	50	500	14,000	0257000801205	4003530177897
	140	80	□	40	50	500	14,000	0257000801405	4003530177903
	160	80	□	40	50	500	14,000	0257000801605	4003530177910
	180	80	□	40	50	500	14,000	0257000801805	4003530182143
	200	80	□	40	50	500	12,000	0257000802005	4003530182181
	220	80	□	40	50	500	12,000	0257000802205	4003530257414
	240	80	□	40	50	—	4,800	0257000802405	4003530257421
260	80	□	40	50	—	4,800	0257000802605	4003530257438	
280	80	□	40	50	—	4,800	0257000802805	4003530257445	
300	80	□	40	50	—	4,800	0257000803005	4003530257452	

■ T-STAR plus, rosca completa

□ T-STAR plus, rosca parcial

NUEVO



Cabeza cilíndrica	110-117
- WIROX	
• Construcción en madera	
-T-STAR <i>plus</i>	112-113
<hr/>	
- ACERO INOXIDABLE A2/A2 bronce	
• Exterior	
- T-STAR <i>plus</i>	
- SPAX para terraza	114
- SPAX para terraza de aluminio	115
• ACERO INOXIDABLE A4	
• Exterior	
- T-STAR <i>plus</i>	
- SPAX para terraza	116
- SPAX para vías y pasarelas	117

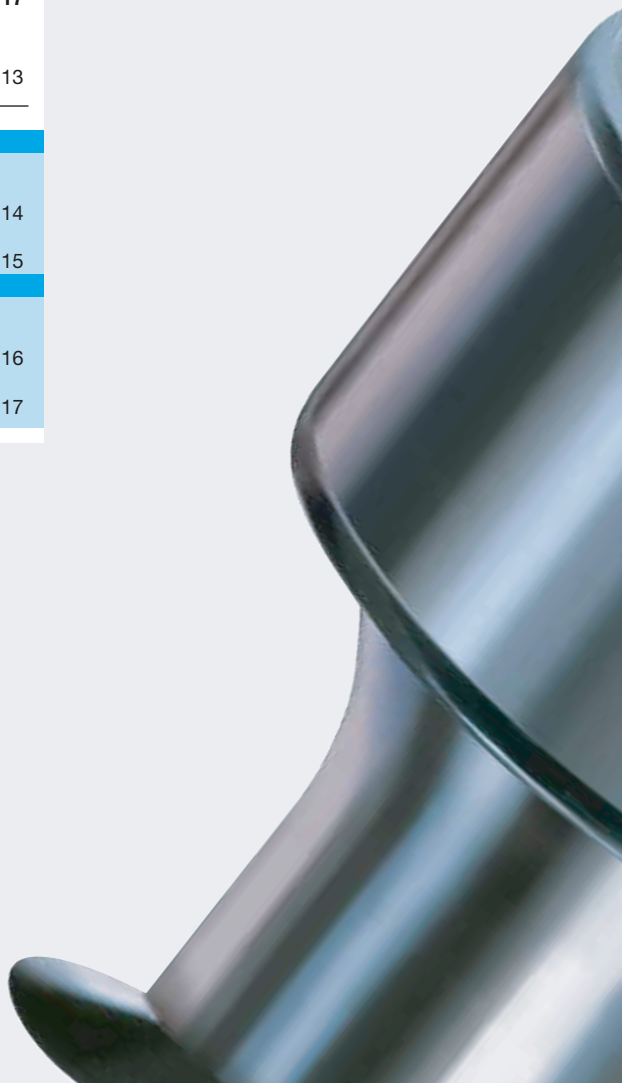

CABEZA CILÍNDRICA

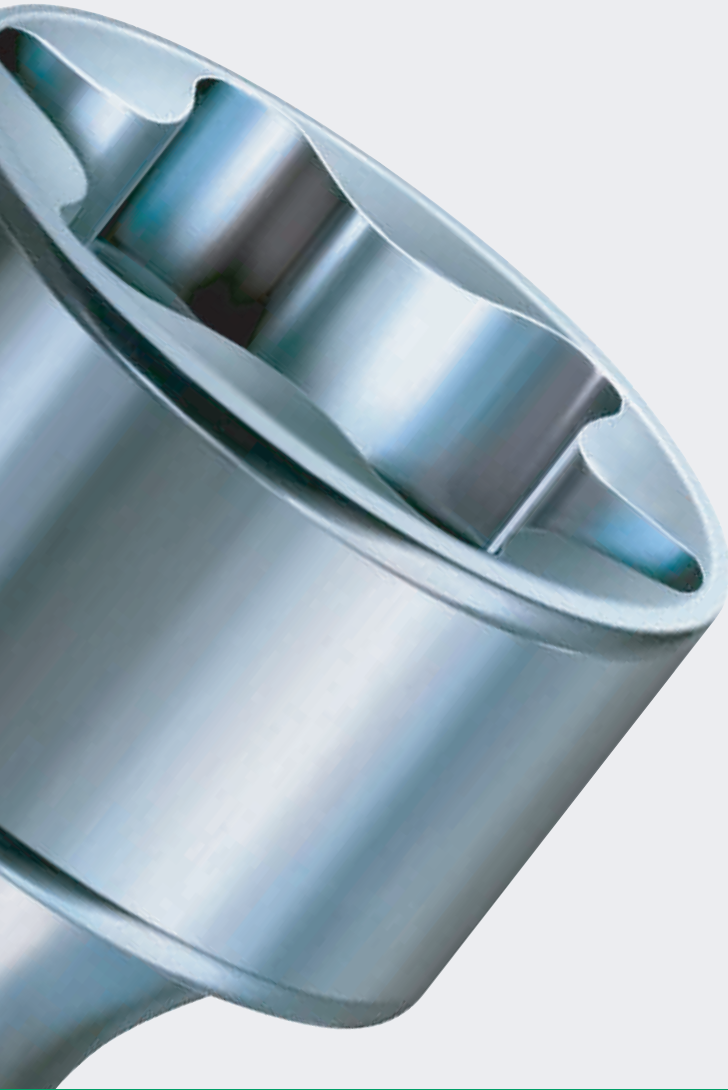

El tornillo de cabeza cilíndrica SPAX es el tornillo ideal para construcciones en madera o para conexiones en fachadas de madera y vidrio.

En construcciones de madera se usa para refuerzos de la resistencia a la tracción transversal y a la compresión transversal, como por ejemplo, en vigas de flexión.



SPAX Iso, tornillo de aislamiento, cabeza cilíndrica,
T-Star plus, rosca de fijación

4CUT

Endurecido, revestimiento sintético

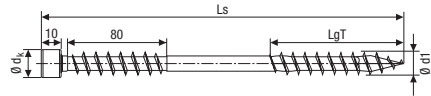

Rosca- Ø	Dimensiones [mm]			Unidad de venta			N° SPAX	Cód. EAN
	Longitud total	Longitud rosca parcial	Tamaño Huella	SPAX Box [uds]	Embalaje de cartón [uds]	Palé		
d1	Ls	LgT	T					
Embalaje estándar								
10.0 Ø dk = 12.3 mm	200	80	50	50	500	12,000	0491011002005	4003530252761
	230	80	50	50	500	4,800	0491011002305	4003530252778
	260	80	50	50	500	4,800	0491011002605	4003530252785
	290	80	50	50	500	4,800	0491011002905	4003530252792
	320	80	50	50	500	3,600	0491011003205	4003530252808
	350	80	50	50	500	3,600	0491011003505	4003530252815

Artículo bajo pedido.



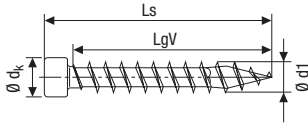

Tornillo construcción en madera, cabeza cilíndrica,
T-Star plus, rosca completa

4CUT

Endurecido, revestimiento sintético



A9J

Rosca- Ø d1	Dimensiones [mm]			Tamaño Huella T	Unidad de venta			N° SPAX	Cód. EAN
	Longitud total Ls	Longitud rosca completa LgV			SPAX Box [uds]	Embalaje de cartón [uds]	Palé		
Embalaje estándar									
6.0 Ø dk = 8.4 mm	80			30	200	2,000	56,000	1211010600805	4003530246364
	100	Rosca		30	100	1,000	32,000	1211010601005	4003530246371
	120	casi		30	100	1,000	28,000	1211010601205	4003530246388
	140	hasta la		30	100	1,000	28,000	1211010601405	4003530246395
	160	cabeza		30	100	1,000	28,000	1211010601605	4003530246401
	180			30	100	1,000	28,000	1211010601805	4003530246418
	200			30	100	1,000	24,000	1211010602005	4003530246425

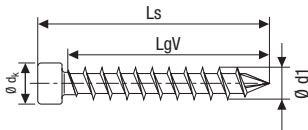

Tornillo construcción en madera, cabeza cilíndrica,
T-Star plus, rosca completa

Punta CUT

Endurecido, revestimiento sintético



A9J

Rosca- Ø d1	Dimensiones [mm]			Tamaño Huella T	Unidad de venta			N° SPAX	Cód. EAN
	Longitud total Ls	Longitud rosca completa LgV			SPAX Box [uds]	Embalaje de cartón [uds]	Palé		
Embalaje estándar									
8.0 Ø dk = 10 mm	160			40	50	500	14,000	1221010801605	4003530257209
	180			40	50	500	14,000	1221010801805	4003530257216
	200			40	50	500	12,000	1221010802005	4003530246432
	220			40	50	500	12,000	1221010802205	4003530246449
	240	Rosca		40	50	-	4,800	1221010802405	4003530246456
	260	casi		40	50	-	4,800	1221010802605	4003530246463
	280	hasta la		40	50	-	4,800	1221010802805	4003530246470
	300	cabeza		40	50	-	4,800	1221010803005	4003530246487
	350			40	50	-	3,600	1221010803505	4003530246494
	400			40	50	-	3,600	1221010804005	4003530246500
	450			40	50	-	3,000	1221010804505	4003530246517
	500			40	25	-	1,500	1221010805005	4003530257223
	550			40	25	-	1,200	1221010805505	4003530257230
	600			40	25	-	1,200	1221010806005	4003530257247

NUEVO





Tornillo para terraza, cabeza cilíndrica,

T-Star plus, rosca de fijación

Punta CUT

Revestimiento sintético

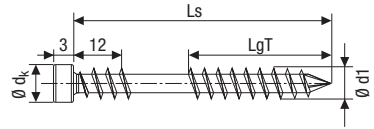

Acero inoxidable A2 1.4567

A2
AISI 304

Rosca- Ø d1	Dimensiones [mm]			Unidad de venta			N° SPAX	Cód. EAN
	Longitud total Ls	Longitud rosca parcial LgT	Tamaño Huella T	SPAX Box [uds]	Embalaje de cartón [uds]	Palé		
Embalaje estándar								
5.0	50	21	25	500	5,000	140,000	0537000500505	4003530164866
Ø dk =	60	26	25	400	2,000	112,000	0537000500605	4003530184383
7.0 mm	70	31	25	250	-	76,000	0537000500705	4003530266881
Embalaje pequeño								
5.0	40	21	25	200	2,000	126,000	0537000500403	4003530165573
	50	21	25	200	2,000	64,000	0537000500503	4003530159589
Ø dk =	60	26	25	100	1,000	63,000	0537000500603	4003530159596
7.0 mm	70	31	25	100	1,000	32,000	0537000500703	4003530159602
	80	36	25	100	1,000	32,000	0537000500803	4003530159619

NUEVO

Tornillo para terraza, cabeza cilíndrica,

T-Star plus, rosca parcial

Punta CUT

Revestimiento sintético

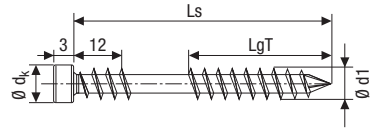

Acero inoxidable A2 1.4567

A2
AISI 304

A2
bronce

Rosca- Ø d1	Dimensiones [mm]			Unidad de venta			N° SPAX	Cód. EAN
	Longitud total Ls	Longitud rosca parcial LgT	Tamaño Huella T	SPAX Box [uds]	Embalaje de cartón [uds]	Palé		
Embalaje pequeño								
5.0	50	21	25	200	2,000	64,000	0537900500503	4003530181948
Ø dk =	60	26	25	100	1,000	63,000	0537900500603	4003530182150
7.0 mm								



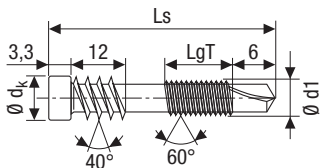

Tornillo para terraza, aluminio, cabeza cilíndrica,
T-Star plus, rosca de fijación

Punta broca

Revestimiento sintético

Acero inoxidable A2 1.4567

A2
AISI 304

Rosca- Ø d1	Dimensiones [mm]			Unidad de venta		Palé	N° SPAX	Cód. EAN
	Longitud total Ls	Longitud rosca parcial LgT	Tamaño Huella T	SPAX Box [uds]	Embalaje de cartón [uds]			
<i>Embalaje pequeño</i>								
5.0	44	18	25	100	1,000	63,000	0557000500443	4003530244001
Ø dk =	48	18	25	100	1,000	63,000	0557000500483	4003530243998
7.0 mm	51	18	25	100	1,000	63,000	0557000500513	4003530243981

NUEVO





Tornillo para terraza, cabeza cilíndrica,

T-Star plus, rosca de fijación

Punta CUT

Revestimiento sintético

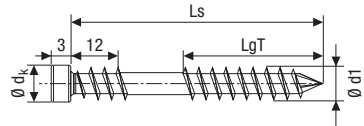

Acero inoxidable A4 1.4578

A4
AISI 316



Rosca- Ø	Dimensiones [mm]			Unidad de venta			Nº SPAX	Cód. EAN
	Longitud total	Longitud rosca parcial	Tamaño Huella	SPAX Box [uds]	Embalaje de cartón [uds]	Palé		
d1	Ls	LgT	T					
Embalaje pequeño								
6.0 Ø d _k = 7.0 mm	40	23	25	200	2,000	64,000	0538000600403	4003530247026
	50	23	25	100	1,000	32,000	0538000600503	4003530246678
	60	28	25	100	1,000	32,000	0538000600603	4003530246708
	70	34	25	100	1,000	32,000	0538000600703	4003530247033
	80	40	25	100	1,000	32,000	0538000600803	4003530247040
	100	40	25	100	1,000	32,000	0538000601003	4003530247064

NUEVO



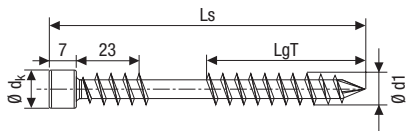

Tornillo para terrazas, vías y pasarelas, cabeza cilíndrica, T-Star plus, rosca de fijación

Punta *CUT*

Revestimiento sintético

Acero inoxidable A4 1.4578

A4
AISI 316

Rosca- Ø d1	Dimensiones [mm]			Unidad de venta			N° SPAX	Cód. EAN
	Longitud total Ls	Longitud rosca parcial LgT	Tamaño Huella T	SPAX Box [uds]	Embalaje de cartón [uds]	Palé		
Embalaje pequeño								
8.0 Ø d _k = 10.0 mm	120	50	40	50	500	14,000	0538000801205	4003530241024



Vástago roscado

118-119

- GALVANIZADO
- Construcciones en madera.
- SPAX Vástago roscado

119

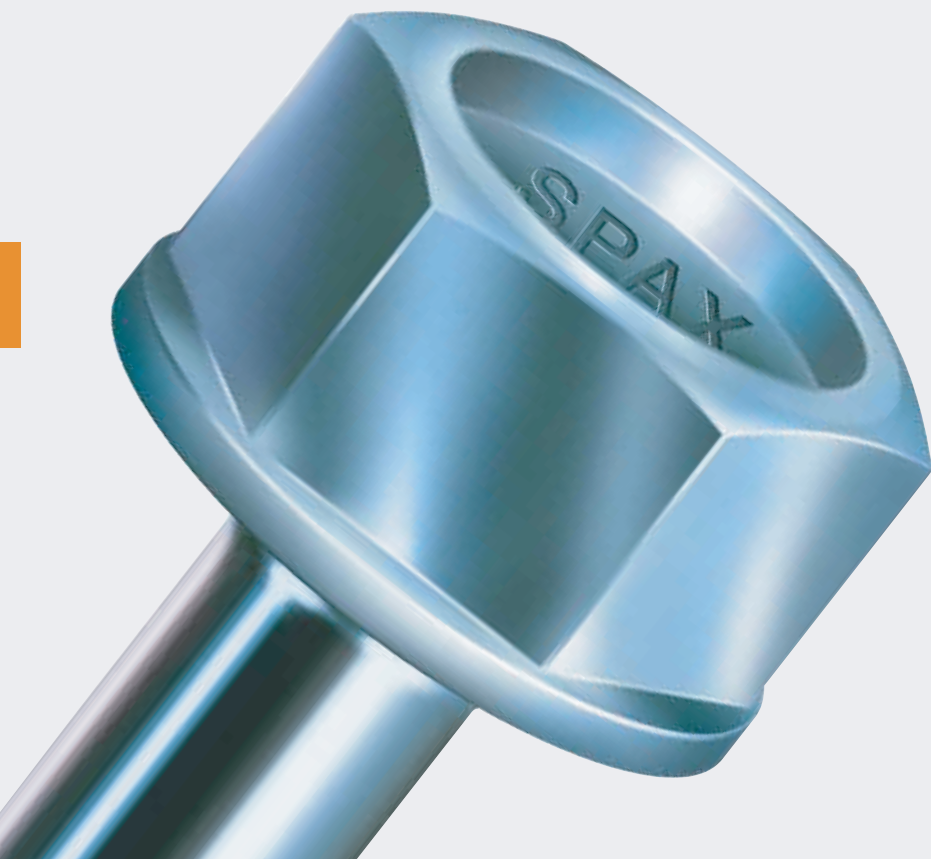

VÁSTAGO ROSCADO

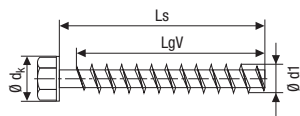
**SPAX vástago roscado, cabeza hexagonal,**

Rosca completa

Cabeza hexagonal

Revestimiento sintético

Galvanizado

A2J

Rosca Ø d1	Dimensiones [mm]		Ancho de llave	Unidad de venta		N° SPAX	Cód. EAN
	Longitud total Ls**	Longitud rosca completa LgV		Haz [uds]	Palé		
Embalaje estándar							
16.0 Ø d _k = 26 mm	800		SW22	25	500	35616000108011	4003530189067
	1,000		SW22	25	500	35616000101011	4003530189074
	1,200	Rosca	SW22	25	500	35616000102011	4003530189081
	1,400	casi	SW22	25	500	35616000103011	4003530189098
	1,600	hasta la	SW22	25	500	35616000104011	4003530189104
	1,800	cabeza	SW22	25	300	35616000105011	4003530189111
	2,000		SW22	25	300	35616000106011	4003530189128

*Medidas de 16 x 1,400 a 16 x 2,000 en palés especiales.

**Otras medidas bajo pedido.



Vástago sin cabeza

120-121

- GALVANIZADO

- Construcción en madera
 - SPAX Vástago roscado

121

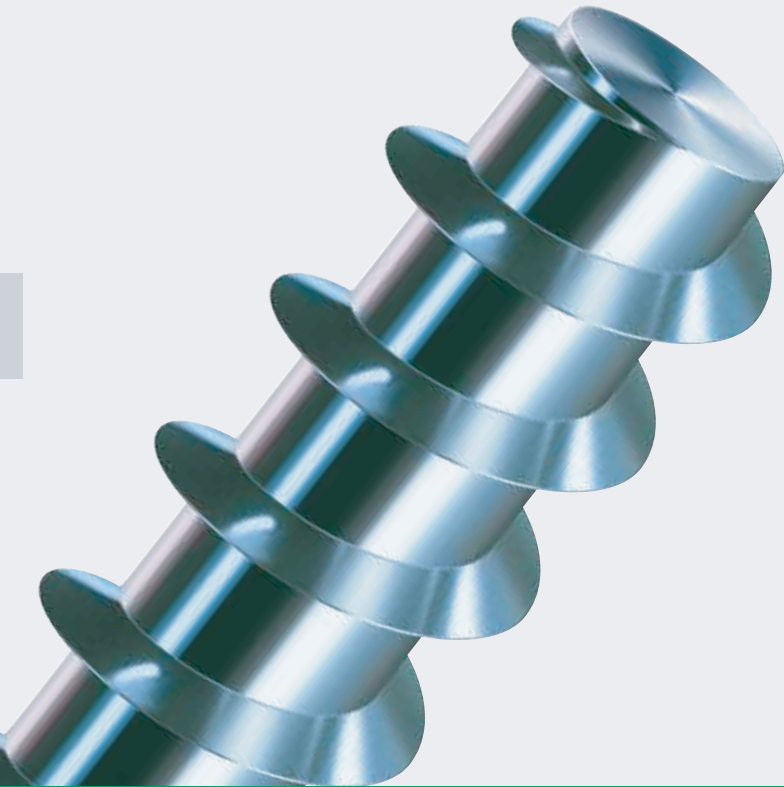

SIN CABEZA

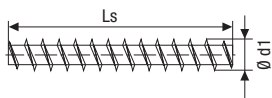

SPAX vástago roscado, sin cabeza

Revestimiento sintético

Galvanizado **A2J**

Rosca Ø d1	Dimensiones [mm]		Unidad de venta		N° SPAX	Cód. EAN
	Longitud total	Ls*	Haz [uds]	Palé		
Embalaje estándar						
16.0	3,000		10	100	35616000201011	4003530192821

*Otras medidas bajo pedido

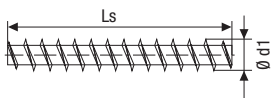

SPAX vástago roscado, sin cabeza

Revestimiento sintético

Acero inoxidable A2 1.4567 **A2**
AISI 304

Rosca Ø d1	Dimensiones [mm]		Unidad de venta		N° SPAX	Cód. EAN
	Longitud total	Ls*	Haz [uds]	Palé		
Embalaje estándar						
16.0	3,000		10	100	35616000301001	4003530254000

*Otras medidas bajo pedido



SPAX accesorios: Llave SPAX para vástagos

Para atornillar vástagos roscados sin cabeza

Ancho de llave (WAF) 11

Véase página 148



Cabeza de centrado

122-123

-ACERO INOXIDABLE A1

• Exterior

- Tornillo SPAX para poste

123



CABEZA DE CENTRADO

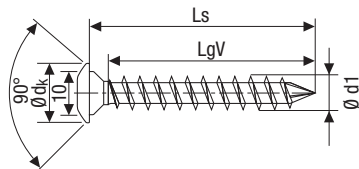

Tornillo para poste, cabeza de centrado,
T-Star *plus*, rosca completa

Punta *CUT*

Autoperforante

Acero inoxidable A1 1.4016

AB1 430

Rosca- Ø d1	Dimensiones [mm]			Unidad de venta			N° SPAX	Cód. EAN
	Longitud total Ls	Longitud rosca completa LgV	Tamaño Huella T	SPAX Box [uds]	Embalaje de cartón [uds]	Palé		
Embalaje pequeño								
8.0 Ø dk = 14.0 mm	50	44	40	50	500	31,500	35708000601001	4003530157356



Cabeza decorativa

124-125

- ACERO INOXIDABLE A2

• Exterior

- SPAX para terraza Bold

125



CABEZA DECORATIVA

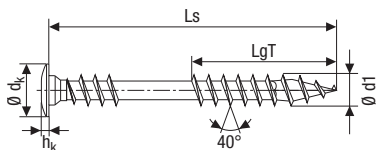

SPAX para terraza Bold, cabeza decorativa,
T-Star plus, rosca de fijación

4CUT

Revestimiento sintético

Acero inoxidable A2 1.4567

A2
AISI 304

Rosca- Ø d1	Dimensiones [mm]			Unidad de venta		N° SPAX	Cód. EAN
	Longitud total Ls	Longitud rosca parcial LgT	Tamaño Huella T	SPAX Box [uds]	Embalaje de cartón [uds]		
Embalaje pequeño							
5.0 Ø dk = 10.0 mm	56	28	20	100	1,000	0567000500563	4003530243240



SPAX Sets de almacenaje 126-135

- WIROX
 - Universal (L-BOXX grande/pequeño) 128-129
 - T-STAR *plus*

- YELLOX
 - Universal (L-Boxx grande)
 - Ranura en cruz Z 130

- ACERO INOXIDABLE A2

- Universal (L-Boxx grande) 131
 - T-STAR *plus*
- Exterior – Terraza (Green Box)
 - T-STAR *plus* 132-133

- ACERO INOXIDABLE A2

- Exterior – Terraza (Green Box)
 - T-STAR *plus* 133

- WIROX
 - Universal (Maletín)
 - T-STAR *plus* 134-135



SPAX SETS



© monkey business maggie shutterstock

SPAX L-BOXX es la solución ideal para una instalación rápida y fácil. Todos los maletines SPAX y los bits correspondientes están inmediatamente disponibles y en el lugar correcto.

Eso hace que el trabajo con SPAX sea aún más eficiente.

El sistema del maletín está bien planificado, es robusto y de alta calidad. Por lo tanto, es el complemento ideal para nuestro programa y satisface nuestras demandas de calidad.



SPAX maleta de montaje L-BOXX, plástico, grande

SPAX cabeza plana, T-Star plus

2.445 tornillos cabeza plana en 16 medidas
más 1 BITcheck T-Star plus

WIROX®

A9J

N° SPAX	500009161019
Cód. EAN	4003530247903
Embalaje	1 ud en embalaje de cartón

275 3,5 x 30 T 20	225 3,5 x 35 T 20	180 4,0 x 30 T 20	175 4,0 x 35 T 20	30 6,0 x 120 T 30
150 4,0 x 40 T 20	150 4,0 x 25 T 20	140 4,0 x 50 T 20	140 4,0 x 45 T 20	
60 5,0 x 60 T 20	100 4,0 x 60 T 20	100 4,5 x 50 T 20	200 4,0 x 20 T 20	60 5,0 x 100 T 20
	BITcheck	60 5,0 x 80 T 20	400 3,5 x 16 T 20	

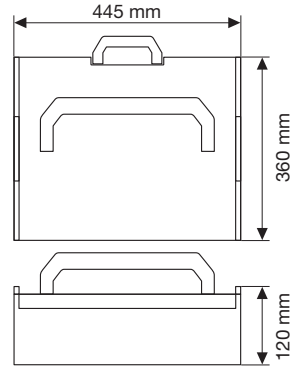

1 x

SPAX maleta de montaje L-BOXX, plástico, grande

sin contenido

N° SPAX	500009166019
Cód. EAN	4003530253256
Embalaje	1 ud de embalaje en cartón





SPAX®

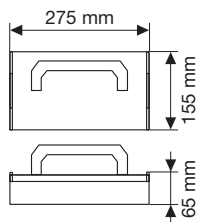

SPAX maleta de montaje L-BOXX Mini, plástico, pequeño

SPAX cabeza plana, T-Star *plus*

700 tornillos cabeza plana en 6 medidas
más 3 SPAX BITS T-Star *plus*



N° SPAX	5000009162019
Cód. EAN	4003530247910
Embalaje	1 ud en embalaje de cartón

200 3,5 x 16 T 20 ■	100 4,0 x 35 T 20 ■	50 4,0 x 50 T 20 ■
200 3,5 x 30 T 20 ■	100 4,0 x 40 T 20 ■	50 4,5 x 60 T 20 □



SPAX maleta de montaje L-BOXX Mini, plástico, pequeño

sin contenido

N° SPAX	5000009167019
Cód. EAN	4003530253263
Embalaje	1 ud en embalaje de cartón





SPAX maleta de montaje L-BOXX, plástico, grande

SPAX cabeza plana. Ranura en cruz Z

2.925 cabeza plana en 17 medidas más 5 Bits

Ranura en cruz Z

YELLOX

**CHROM(VI)
FREE**

A2L

Nº SPAX	5000009164019
Cód. EAN	4003530252303
Embalaje	1 ud en embalaje de cartón

75 4,5 x 60 Z 2 ●	75 4,5 x 50 Z 2 ○	200 3,5 x 25 Z 2 ●	100 4,0 x 45 Z 2 ●	100 4,0 x 50 Z 2 ○
50 5,0 x 60 Z 2 ○	75 4,5 x 45 Z 2 ●	100 4,0 x 40 Z 2 ●	150 3,5 x 30 Z 2 ●	
	400 3,0 x 10 Z 1 ●	150 3,5 x 40 Z 2 ●	150 3,5 x 35 Z 2 ●	50 6,0 x 80 Z 3 ●
50 5,0 x 70 Z 2 ●	400 3,0 x 16 Z 1 ●	400 2,5 x 25 Z 1 ●	400 2,5 x 20 Z 1 ●	

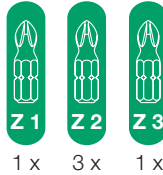
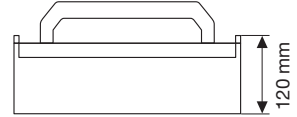
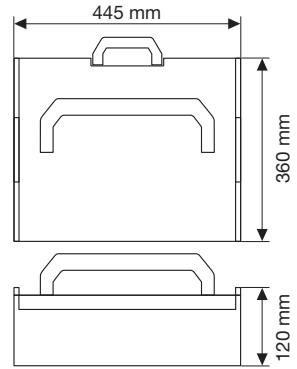

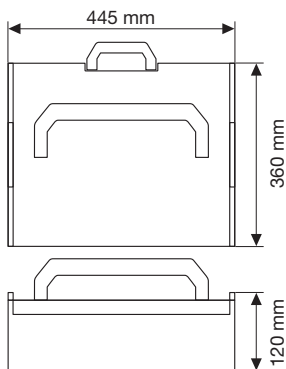

SPAX maleta de montaje L-BOXX, plástico, grande

SPAX cabeza plana, T-Star plus

1.065 cabeza plana en 17 medidas
más 5 BITs T-Star plus

Acero inoxidable A2 1.4567

A2
AISI 304

Nº SPAX	5000009165019
Cód. EAN	4003530252310
Embalaje	1 ud en embalaje de cartón

50 4,0 x 60 T 20	50 5,0 x 50 T 20	100 3,5 x 30 T 15	50 5,0 x 60 T 20	50 5,0 x 80 T 20
50 4,0 x 50 T 20	75 4,5 x 35 T 20	50 4,5 x 50 T 20	100 3,5 x 35 T 15	
	100 3,0 x 35 T 10	30 6,0 x 40 T 30	30 6,0 x 60 T 30	30 5,0 x 90 T 20
75 4,0 x 40 T 20	75 4,0 x 30 T 20	75 4,0 x 25 T 20	75 4,0 x 20 T 20	

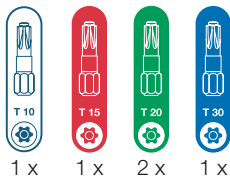



SPAX GREEN BOX para terrazas de madera

Profiset accesorios para 25-28 m²
Aplicación: Madera sobre madera

- 850 SPAX cabeza cilíndrica 5 x 50
- T-Star *plus* acero inoxidable A2
- 12 SPAX separadores
- 5 SPAX T-Star *plus* T25 BITS
- 1 broca SPAX avellanadora

Acero inoxidable A2 1.4567

A2
#S1 304

Nº SPAX	500009010009
Cód. EAN	4003530247538
Embalaje	2 cajas por embalaje

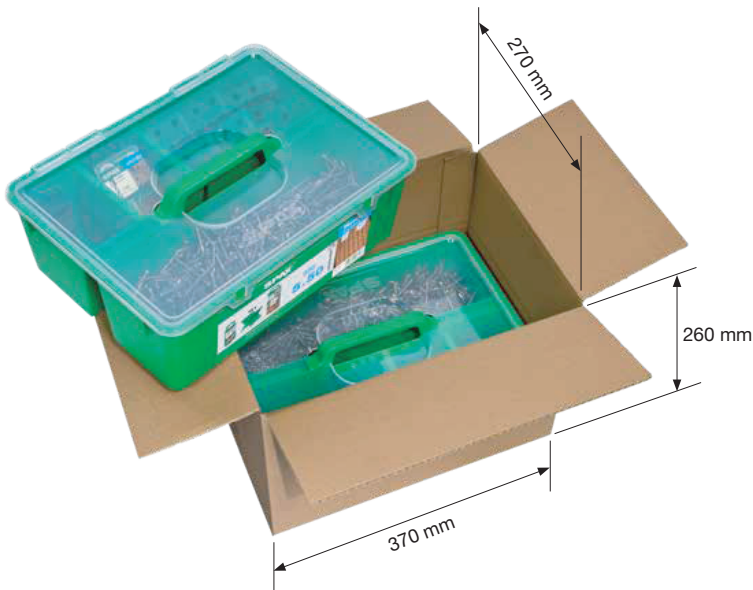
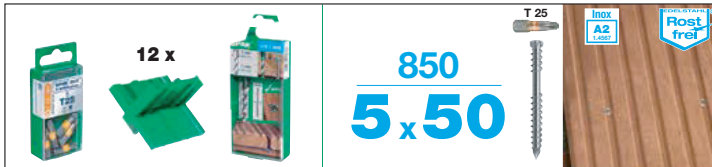



SPAX GREEN BOX para terrazas de madera

Profiset accesorios para 25-28 m²
 Aplicación: Madera sobre madera

- 850 SPAX cabeza cilíndrica 5 x 60
 T-Star *plus* acero inoxidable A2
- 12 SPAX separadores
- 5 SPAX T-Star *plus* T25 BITS
- 1 broca SPAX avellanadora

Acero inoxidable A2 1.4567

A2
 AISI 304

Nº SPAX	500009030009
Cód. EAN	4003530248962
Embalaje	2 cajas por embalaje

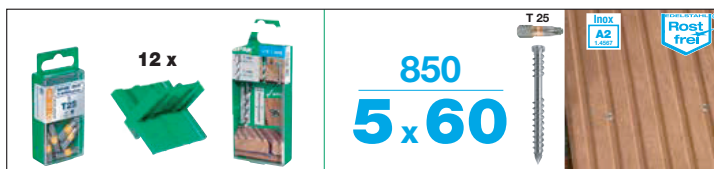

SPAX GREEN BOX para terrazas de madera

Profiset accesorios para 20-23 m²
 Aplicación: Madera sobre madera

- 700 SPAX cabeza cilíndrica 6 x 60
 T-Star *plus* acero inoxidable A4
- 12 SPAX separadores
- 5 SPAX T-Star *plus* T25 BITS
- 1 broca SPAX avellanadora

Acero inoxidable A4 1.4578

A4
 AISI 316

Nº SPAX	500009050009
Cód. EAN	4003530248986
Embalaje	2 cajas por embalaje

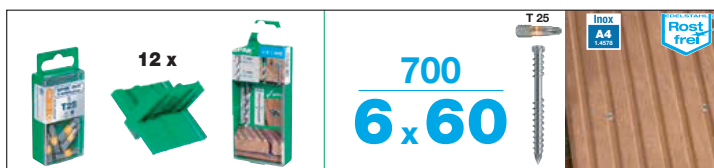

NUEVO



SPAX Box apilamiento modular T-Loc I

SPAX cabeza plana, T-Star plus

1.380 tornillos cabeza plana en 12 medidas
más 5 SPAX BITS T-Star plus



WIROX

A9J

Nº SPAX	5000009172009
Cód. EAN	4003530255496
Embalaje	1 ud en embalaje de cartón

300 3,5 x 16 T 20	150 4 x 35 T 20	80 4,5 x 50 T 20	60 5 x 60 T 20
150 3,5 x 30 T 20	150 4 x 40 T 20	80 4,5 x 60 T 20	60 5 x 70 T 20
150 4 x 30 T 20	100 4 x 50 T 20	60 5 x 50 T 20	40 5 x 80 T 20



5 x

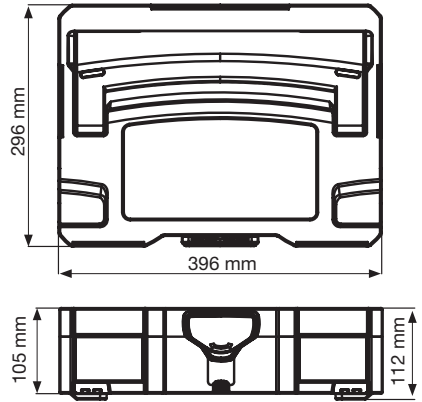

SPAX Box apilamiento modular
con la máxima aprobación de
TANOS GmbH. www.TANOS.de





Lock para cerrado fácil

Open para apertura fácil, incluso apilados y conectados.

Connect para una rápida conexión múltiple de cajas.



Tacos SPAX

- SPAX Taco
- SPAX Taco con tornillo

136-139

138

139



TACOS SPAX



©photo_500_adobeistock

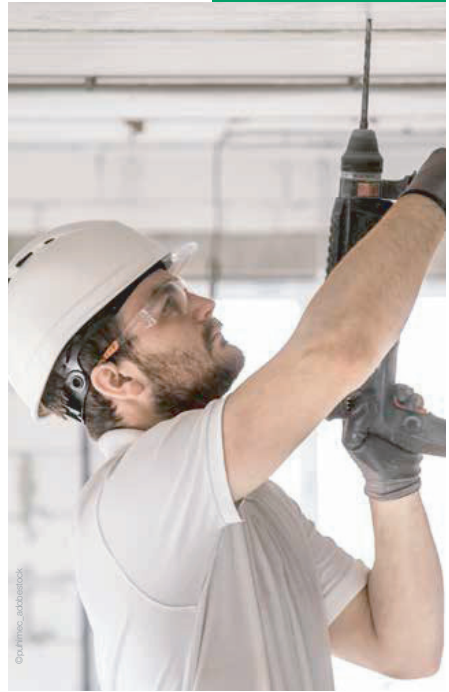

©photo_486666666

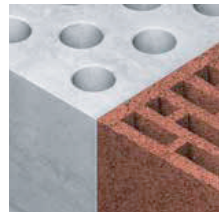

Tomillos y tacos, naturalmente de SPAX. Resultados de montaje sin defectos gracias a la combinación perfecta de tornillo SPAX y el taco SPAX.

El nylon de alta calidad hace que el taco sea particularmente resistente, duradero y altamente resistente.

Taco SPAX

Tipo SD

Taco de expansión

Nylon

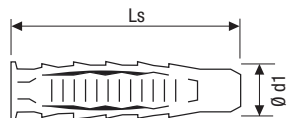

Taladro Ø d1	Dimensiones [mm]		SPAX Box [uds]	Unidad de venta		N° SPAX	Cód. EAN
	Longitud total Ls	Tornillo recomendado Ø		Master box [uds de venta]	Palé		
<i>Embalaje estándar</i>							
5,0	25	3-4	150	750	240.000	4100000500257	4003530257018
6,0	30	4-5	80	400	128.000	4100000600307	4003530257049
	45	4-5	50	250	80.000	4100000600457	4003530257070
8,0	40	4,5-6	40	200	64.000	4100000800407	4003530257537

NUEVO

SPAX tornillo con taco, cabeza plana,

Tipo ND

Taco y tornillo

Nylon, acero galvanizado

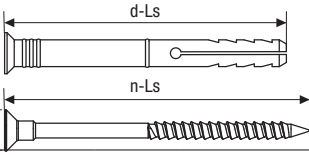

Taladro Ø d1	Dimensiones[mm]				Unidad de venta			N° SPAX	Cód. EAN
	Longitud total Ls	Tamaño punta Z	Min. profund. del guiado	Max. longitud útil	SPAX Box [uds]	Master box [uds de venta]	Palé		
<i>Embalaje estándar</i>									
6,0	40	2	25	15	50	150	65.100	4861080600406	4003530266980
	60	2	25	35	50	150	33.600	4861080600606	4003530266997
8,0	80	3	40	40	50	150	28.800	4861080800806	4003530267000
	100	3	40	60	50	150	24.000	4861080801006	4003530267017

Disponibilidad estimada Marzo 2020

NUEVO

SPAX Accesorios

140-157

- Programa BIT 142-144
- Kit de surtido 145-147
- Accesorios construcción en madera 148
- Accesorios para terraza 150-155
- Tapones de plástico 156-157

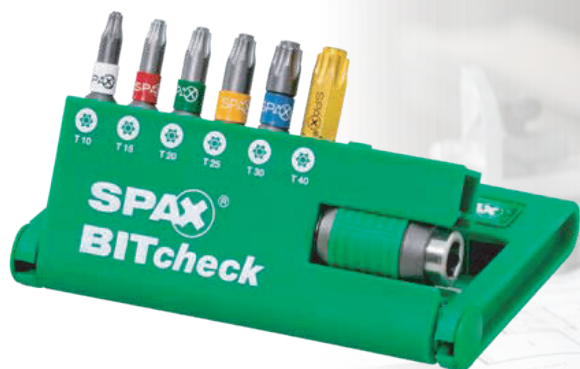

SPAX ACCESORIOS



© photographie.eu/andrea stock

Las puntas SPAX para atomilladores manuales, eléctricos, neumáticos y de batería convencer por su exacta precisión de ajuste y óptimos valores de transmisión de fuerza, lo que unido a su dureza nos garantiza una larga vida útil.

Puntas SPAX BITS

T-STAR plus, longitud 25 mm

Asiento perfecto y mejor admisión de la punta, por ejemplo, al efectuar trabajos por encima de la cabeza.







Las puntas SPAX para atornilladores manuales, eléctricos y neumáticos y de batería convienen por su exacta precisión de ajuste y óptimos valores de transmisión de fuerza, lo que unido a su dureza nos garantiza una larga vida útil.

Los soportabits y las puntas SPAX son herramientas de calidad.

Puntas SPAX T-STAR plus bits en SPAX CUT-CASE

Contenido en envases de un mismo tipo:
10 blísters con 5 o 50 unidades en cada SPAX CUT-CASE de 25 mm por largo de caja



						
Tamaño punta	T 10	T 15	T 20	T 25	T 30	T 40
Rosca Ø [mm]	3.0	3.5	3.5 4.0 4.5 5.0	Decking 5.0 para A2 6.0 para A4 Fex 5,5 para tornillo de acoplamiento	6.0	8.0
5 bits por caja, embalaje a 10 cajas en SPAX CUT-CASE = 50 bits						
Nº SPAX	5000009182109	5000009182159	5000009182209	5000009182259	5000009182309	5000009182409
Cód. EAN	4003530239632	4003530239649	4003530239656	4003530239663	4003530239670	4003530239687



Punta SPAX BITS

T-STAR plus, longitud 50 mm

Contenido en envases de un mismo tipo:
10 blisters con 5 o 50 unidades en cada caja SPAX CUT-CASE de 50 mm por largo de caja

Tamaño huella	T 10	T 15	T 20	T 25	T 30	T 40
Rosca Ø [mm]	3.0	3.5	3.5 4.0 4.5 5.0	Decking 5.0 para A2 6.0 para A4 Fex 5,5 para tornillo de acoplamiento	6.0	8.0
5 bits por caja, embalaje a 10 cajas en SPAX CUT-CASE = 50 bits						
N° SPAX	5000009183109	5000009183159	5000009183209	5000009183259	5000009183309	5000009183409
Cód. EAN	4003530192852	4003530192869	4003530192876	4003530192883	4003530192890	4003530192906



SPAX BITS

T-STAR plus, longitud 35 mm

En blíster (5 blisters con 1 bit cada uno)

Tamaño	T 50
Rosca Ø [mm]	10.0 and 12.0
1 bit por caja, embalaje a 5 cajas = 5 bits	
N° SPAX	5077701516035
Cód. EAN	4003530241918



Instrucciones de uso:

La punta SPAX Bit T-STAR plus portabrocas con una longitud de 35 o 50 mm no debe utilizarse en el suportabits, sino que debe fijarse directamente en el suportabits del destornillador inalámbrico o taladro.

SPAX-BITcheck

1 soporte BIT Rapidaptor + 6 SPAX BITS T-STAR plus bits, 25 mm de longitud, unidad de venta 10 BITcheck en expositor de mostrador.

Asiento perfecto y mejor admisión de la punta, por ejemplo, al efectuar trabajos por encima de la cabeza.

Más poder

Larga durabilidad

Enroscado rápido

Mayor fijación

Fácilmente identificables gracias a sus colores

Nº SPAX	5000009181309
Cód. EAN	4003530239922



SPAX-BITcheck T-STAR plus:

1 x soporte bit Rapidaptor de 50 mm 

1 x T 10 	1 x T 20 	1 x T 30 
1 x T 15 	1 x T 25 	1 x T 40 

Funcionamiento del **Rapidaptors** con imán permanente y mecánica easy-out

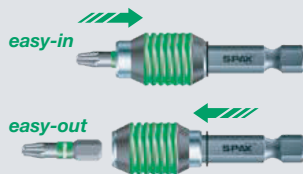

Puntas SPAX-BITS

Ejemplo del código de color



SPAX-Speedy. La estantería sobre ruedas

Variable, práctico y versátil.

Con 5 estantes variables y 4 ruedas de maniobra

El contenido es sólo un ejemplo y no está incluido en la oferta.



SPAX-Speedy. La estantería sobre ruedas

Medidas estantería sobre ruedas W x H x D [mm]	Medida interior estantes [mm]	Embalaje	Nº SPAX	Cód. EAN
1,090 x 1,440 x 760	1,000 (cada uno)	1 ud por palet	500000580005	4003530241567

SPAX Rack – El sistema de módulos de estantería

Fácil montaje:

La inserción de los módulos permite un montaje rápido y fácil sin ejercer fuerza y sin necesidad de herramientas adicionales.

Unidad de 1 metro	
Componentes de una estantería unidad completa (1.00 m)	
Nº SPAX	5000003500001
Cód. EAN	4003530252556

Unidad de 1 metro	
Unidad completa, A+B solo 1 pieza	
Nº SPAX	5000003500002
Cód. EAN	4003530253089

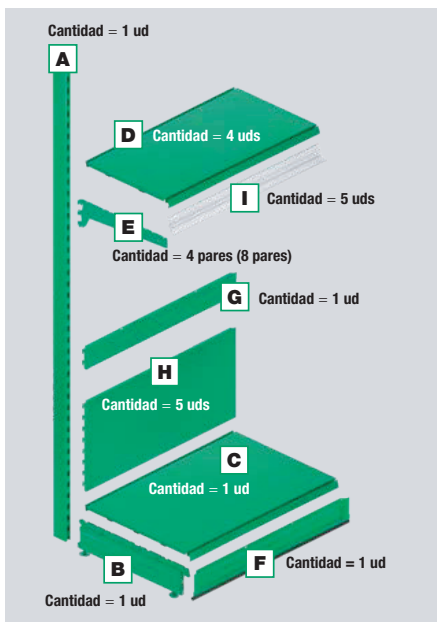
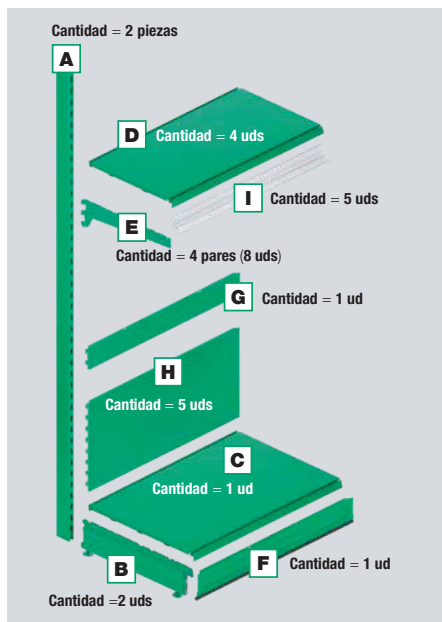

Descripción individual de los módulos de estantería

Denominación del módulo		Medidas	S
A	Pilar, largo	W 30 mm, H 2,200 mm, D 80 mm	5000003500010
B	Pie	W 570 mm, H 160 mm	5000003500020
C	Estantería	W 1,000 mm, D570 mm	5000003500030
D	Estantería	W 1,000 mm, D 470 mm	5000003500040
E	1 par de soportes (2 uds))	W 30 mm, D 470 mm	5000003500050
F	Cubierta de la base	W 1,000 mm, H 160 mm	5000003500060
G	Pared trasera	W 1,000 mm, H 100 mm	5000003500070
H	Pared trasera	W 1,000 mm, H 400 mm	5000003500080
I	Rieles	W 1,000 mm, H 40 mm	5000003500090
J	Pilar corto	W 30 mm, H 1,400 mm, D 80 mm	5000003500011



Casquillo de atornillado para vástagos roscados SPAX

Para vástagos roscados sin cabeza

Ancho de llave (WAF) 11



Nº SPAX	5001900900011
Cód. EAN	4003530192845
Embalaje	1 ud/caja

Combina con SPAX vástago roscado, véase página 121

Calibre de atornillado

Para aislamiento del tejado

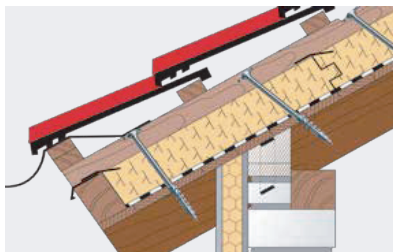

Nº SPAX	5001120800011
Cód. EAN	4003530168956
Embalaje	1 ud/caja

SPAX Kaiman pro

Sargento para enderezar tablas reviradas

Alineador de atomillado (Liner)

Distanciador de juntas de 4 anchuras diferentes: 4, 5, 6 y 7

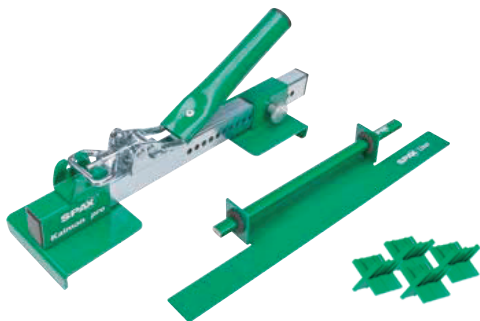

Nº SPAX	5009409872009
Cód. EAN	4003530241093
Embalaje	1 ud/estuche

SPAX Pads

Protege la estructura inferior de madera contra la humedad del suelo

Medidas: L x W x H = 100 x 100 x 8 mm

Paquete de 25 unidades, 250 unidades en máster box

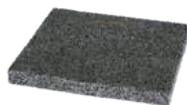

Nº SPAX	5000009186609
Cód. EAN	4003530191688
Embalaje	10x25 uds en cartón de envase

NUEVO



SPAX Cinta para cubierta

Protege la estructura inferior de la madera contra el agua de lluvia

Cinta de polietileno de baja densidad, autoadhesiva, extraíble sin residuos

Grosor del material: 0,5 mm

Tamaño: L x W x H = 30 m x 87 mm x 0,5 mm

N° SPAX.	5000009186419
Cód. EAN	4003530248566
Embalaje	5 rollos en envase de cartón



SPAX Spacer

Calibre para 4 anchuras de juntas: 4, 5, 6, 7 mm

Tenga en cuenta las recomendaciones del proveedor de madera

12 unidades en caja de plástico con asa, 36 unidades en mástex box

N° SPAX	5000009186209
Cód. EAN	4003530191640
Embalaje	36,3 x 12 en embalaje de cartón

NUEVO



SPAX Stick pro

Fijación no visible de terrazas de madera

Incluye los SPAX con cabeza cilíndrica

Puede ser usado en madera y aluminio

Medidas: L x W x H = 60 x 20 x 8 mm

40 unidades en caja de plástico con asa, 120 unidades en máster carton

SPAX Stick pro 1 m²

N° SPAX	5009422556609
Cód. EAN	4003530252433
Embalaje	3 cajas en master carton

120 uds en caja de plástico con asa

SPAX Stick pro 3 m²

N° SPAX	5009422556619
Cód. EAN	4003530252440
Embalaje	1 caja

Nota de aplicación: No apropiado para maderas con fuertes ondulaciones de las fibras (Cumariú, Massanduba, etc...) y tablas de material compuesto (WPC). En maderas importadas muy duras se recomienda un taladro previo con 3 mm y una distancia de la estructura inferior de 40 cm como máximo.

SPAX Air

Separa la tabla de la estructura inferior

Garantiza una ventilación óptima por la parte inferior

Evita acumulación de humedad

Garantiza la distancia correcta entre tablas

Altura estructural 4,0 mm

Tamaño: L x W x H = 90 x 28 x 4 mm

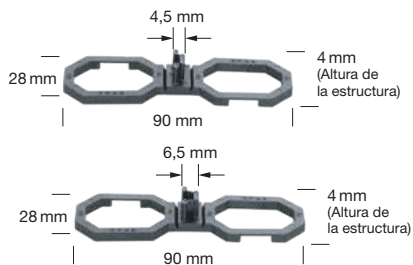

40 unidades en caja de plástico con asa, 120 unidades en máster carton		
40 uds por caja	Ancho del hueco 4.5 mm	Ancho del hueco 6.5 mm
Nº SPAX	5009422544009	5009422564009
Cód. EAN	4003530241338	4003530241345
Embalaje	3 uds/master carton	

100 uds en caja de plástico con asa		
100 uds por caja	Ancho del hueco 4.5 mm	Ancho del hueco 6.5 mm
Nº SPAX	5009422545009	5009422565009
Cód. EAN	4003530241239	4003530241246
Embalaje	1 caja	1 caja



SPAX drive STOP

Tope de profundidad variable

Alojamiento BIT de 1/4" con anillo de fijación

1 SPAX T-STAR plus T25 BIT

3 anillos de fieltro como recambio

No es adecuado ppara usar con llaves de impacto

Nº SPAX	500009186909
Cód. EAN	4003530189036
Embalaje	1 ud en blister



* Para un cambio de BIT desatornille el tope de profundidad para acceder mejor a la punta (BIT). Si la punta (BIT) está tensa, use si fuera necesario una pinza para soltar la punta (BIT) del soporte.



SPAX Free lift

Apropiado para soportes de metal con una anchura de 91 mm

Para soporte con ancho de 20-75 mm

La altura se puede ajustar de forma continua hasta 30 mm

Para compensar fácilmente diferencias de altura en la construcción de terrazas

Nº SPAX	5009400009109
Cod. EAN	4003530241529
Embalaje	15 bolsas/master carton (3 uds/bolsa)



SPAX Lift 3/5

Para soportes de terraza con ancho de 20 a 75 mm

La altura se puede ajustar de forma continua entre 33 y 50 mm

Cargas permitidas hasta 800 kg

Diámetro del plato 220 mm

Para una superficie de aprox. 6 m²

Nº SPAX	5009435355009
Cod. EAN	4003530242199
Embalaje	10 bolsas/master carton (3 uds/bolsa)



SPAX Lift 5/9

Para soportes de terraza con ancho de 20 a 75 mm

La altura se puede ajustar de forma continua entre 55 y 82 mm

Cargas permitidas hasta 800 kg

Diámetro del plato 220 mm

Para una superficie de aprox. 5 m²

Nº SPAX	5009459558509
Cód. EAN	4003530242205
Embalaje	8 bolsas/masterbox (3 uds/bolsa)



SPAX Extension

Pieza de extensión para SPAX Free Lift y Lift 5/9

Elemento de montaje fácil, 35 mm de altura

Permite la adaptación también en diferencias de altura mayores (por ejemplo en independientes)

Nº SPAX	5009400003500
Cód. EAN	4003530189258
Embalaje	18 bolsas/masterbox (8 uds/bolsa)

SPAX Broca progresiva

Step drill con 2 fases de taladro de 4,1 mm \varnothing y 6,5 mm \varnothing , longitud del husillo 48 mm

N° SPAX	5009409873005
Cód. EAN	4003530189388
Embalaje	5 uds en blísters individuales

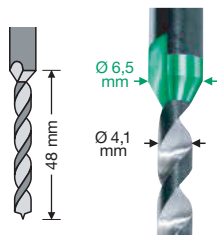

SPAX Avellanador step drill 4

Broca de 4 mm

- 1 x broca para madera 4 mm \varnothing
- 1 x avellanador 6,5 mm \varnothing
- 1 x llave hexagonal interior

Brocas intercambiables

La longitud de la broca se puede ajustar

Apropiada especialmente para los tornillos de terraza SPAX ACCESORIOS de 40 a 70 mm de longitud

Para tornillos de cubierta SPAX en las longitudes de 80 y 100 mm, cambie los taladros y utilice un taladro helicoidal de madera HSS-G largo, 4 mm \varnothing , longitud total 150 mm, de FAMAG, tipo 1599.104

N° SPAX	5000009186049
Cód. EAN	4003530241581
Embalaje	1 set

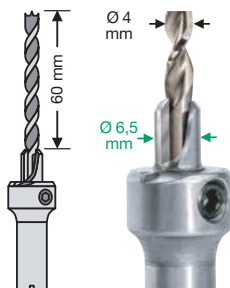



SPAX drill 5,2

Broca de madera con vástago de \varnothing 4,0 mm y husillo de \varnothing 5,2 mm

Longitud del husillo 19 mm

Recomendación:

Usar en combinación con el avellanador de SPAX de 4 mm

Nº SPAX.	5009409875005
Cód. EAN	4003530248139
Embalaje	5 uds en blíster individuales

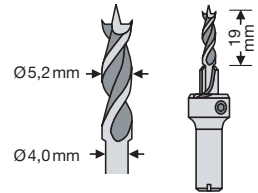

SPAX Avellanador 6

Broca de 6 mm

2 x broca para madera de 6 mm \varnothing

1 x avellanador de 9,5 mm \varnothing

1 x llave hexagonal

Brocas intercambiables

La longitud de la broca se puede ajustar

Especialmente apropiado para SPAX vías y pasarelas (pág. 117)





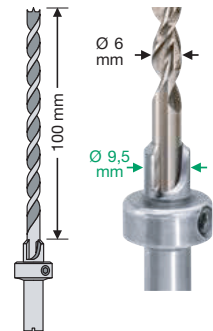



Nº SPAX	5000009186069
Cód. EAN	4003530241598
Embalaje	1 set



**Tapones de plástico
para SPAX con taladro en la cabeza**

Embalaje a 500 uds





				
Color	blanco	negro	gris	beige
Nº SPAX	5000009200009	5000009900009	5000009800009	5000009400009
Cód. EAN	4003530039409	4003530039416	4003530039423	4003530039461
				
Color	ocre	marrón claro	marrón oscuro	
Nº SPAX	5000009300009	5000009500009	5000009700009	
Cód. EAN	4003530039430	4003530039447	4003530039454	

Combinelo con tornillo SPAX con taladro en la cabeza, véase pág. 46

**Tapones de plástico para
SPAX RA cabeza plana**

Embalaje a 500 uds

		
Color	blanco	negro
Nº SPAX	50000080000001	50000080000101
Cód. EAN	4003530043246	4003530043253

Combinelo con SPAX RA cabeza plana, véase pág. 173



Espacial cabeza plana - 160-165**WIROX**

- FEX-KS – para herrajes 161
- FEX-H – para ventana de madera 162
- FEX-A – perforador de ventana 163
- FEX – tornillo de acoplamiento 164
- FEX – tornillo combinado 165

Cabeza plana con elemento 166-167**de centrado - WIROX**

- FEX – con elemento de centrado 167

Cabeza con encaje 168-169**- WIROX**

- FEX-RS – el tornillo para persianas 169

Cabeza cilíndrica 170-171**- WIROX**

- Montaje de ventana 171
 - SPAX Anclaje de marcos

Cabeza plana 172-173**- WIROX**

- Montaje de ventana 173
 - SPAX Anclaje de marcos

RESUMEN

PRODUCTO PARA VENTANAS



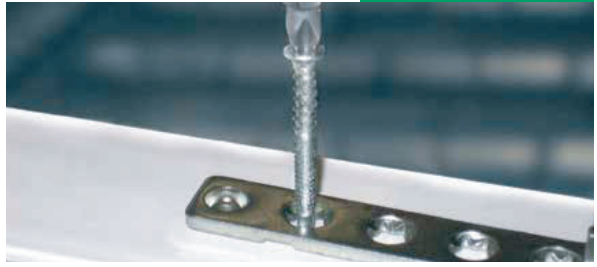

© ah_loobox_sadbestock

La serie FEX, SPAX ofrece una gama completa para la fabricación e instalación de Ventanas. También en este campo, SPAX tiene la solución adecuada para cada material y cada aplicación con la serie FEX.

Especial cabeza plana -

160-165

WIROX

- FEX-KS - para herrajes 161
- FEX-H - para ventana de madera 162
- FEX-A - perforador de ventana 163
- FEX - tornillo de acoplamiento 164
- FEX - tornillo combinado 165

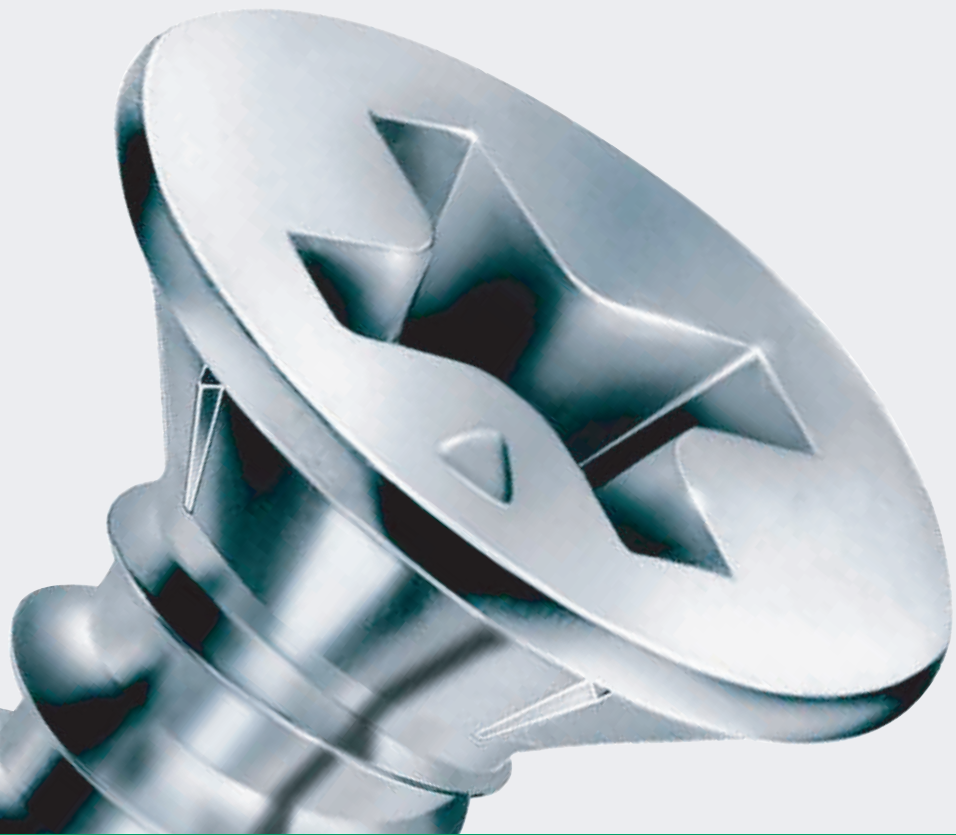

CABEZA PLANA ESPECIAL

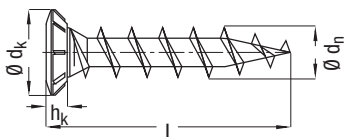

FEX-KS, especial cabeza plana

Ranura en cruz H, rosca especial

Nervios de frenado, punta afilada autopercutorne

Endurecido, revestimiento sintético



A9J

Rosca- Ø d _n	Dimensiones [mm]			Unidad de venta		N° SPAX	Cód. EAN
	Longitud total l	Altura de la cabeza h _k	Tamaño Huella H	SPAX Box [uds]	Embalaje de cartón [uds]		
Embalaje estándar							
4.0 Ø d _k = 7.0 mm	16	2.4	2	1,000	10,000	1411010400165	4003530248214
	20	2.4	2	1,000	10,000	1411010400205	4003530248221
	22	2.4	2	1,000	10,000	1411010400225	4003530248238
	25	2.4	2	1,000	10,000	1411010400255	4003530248245
	30	2.4	2	1,000	10,000	1411010400305	4003530248269
	35	2.4	2	1,000	10,000	1411010400355	4003530248276
	40	2.4	2	1,000	10,000	1411010400405	4003530248283
	45	2.4	2	500	5,000	1411010400455	4003530248290
55	2.4	2	500	5,000	1411010400555	4003530248306	
Tornillo de reparación para perfiles de plástico							
5.0 Ø d _k = 7.0 mm	25	2.4	2	1,000	10,000	1411010500255	4003530248399
	40	2.4	2	500	5,000	1411010500405	4003530248375





FEX-H, especial cabeza plana

T-STAR *plus*, rosca parcial

Nervios de frenado, 4CUT

Endurecido, revestimiento sintético

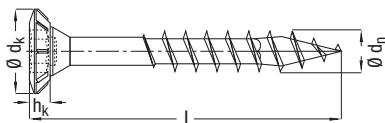

WIROX

A9J

Rosca- Ø	Dimensiones [mm]			Unidad de embalaje			N° SPAX	Cód. EAN
	Longitud total	Altura de la cabeza	Tamaño Huella	SPAX Box [uds]	Embalaje de cartón [uds]	Palé		
d_n	l	h_k	T					
Embalaje estándar								
4.0	30	2.4	15	1,000	10,000	320,000	35704012301011	4003530243769
$\emptyset d_k =$	35	2.4	15	1,000	10,000	280,000	35704012302011	4003530243806
7.3 mm	40	2.4	15	1,000	10,000	280,000	35704012303011	4003530243783

FEX-H, especial cabeza plana

Ranura en cruz Z, rosca parcial

Nervios de frenado, 4CUT

Endurecido, revestimiento sintético

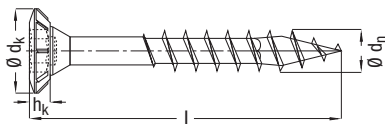

WIROX

A9J

Rosca- Ø	Dimensiones [mm]			Unidad de venta			N° SPAX	Cód. EAN
	Longitud total	Altura de la cabeza	Tamaño Huella	SPAX Box [uds]	Embalaje de cartón [uds]	Palé		
d_n	l	h_k	Z					
Embalaje estándar								
4.0	30	2.4	2	1,000	10,000	320,000	35704012401011	4003530159961
$\emptyset d_k =$	35	2.4	2	1,000	10,000	280,000	35704012402011	4003530243738
7.3 mm	40	2.4	2	1,000	10,000	280,000	35704012403011	4003530243745



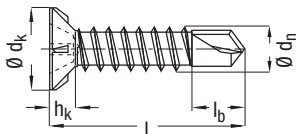

FEX-A, especial cabeza plana

Ranura en H, rosca gruesa

Nervios de frenado, punta perforadora

Endurecido, revestimiento sintético



Rosca- Ø dn	Dimensiones [mm]			Tamaño Huella H	Unidad de venta		Nº SPAX	Cód. EAN
	Longitud total l	Longitud punta perforadora lb	Altura de la cabeza hk		SPAX Box [uds]	Embalaje de cartón [uds]		
<i>Embalaje estándar</i>								
3.9 Ø dk = 7.5 mm	13	4.5	2.3	2	1,000	10,000	1401470390135	4003530155840
	16	4.5	2.3	2	1,000	10,000	1401470390165	4003530122712
	19	4.5	2.3	2	1,000	10,000	1401470390195	4003530122729
	25	4.5	2.3	2	1,000	10,000	1401470390255	4003530122743
	32	4.5	2.3	2	1,000	10,000	1401470390325	4003530122750
	38	4.5	2.3	2	1,000	10,000	1401470390385	4003530122767

Acabado cambiado a WIROX.





FEX, especial cabeza plana

Ranura en cruz H, rosca de doble plomo

Nervios de frenado, punta CUT

Endurecido, revestimiento sintético

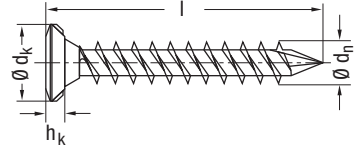

WIROX

A9J



Rosca- Ø	Dimensiones [mm]			Unidad de venta		N° SPAX	Cód. EAN
	Longitud total	Altura de la cabeza	Tamaño Huella	SPAX Box [uds]	Palé		
dn	l	hk	H				
Embalaje estándar							
4.0 Ø dk = 7.0 mm	25	2.4	2	3,000	441,000	0521470400252	4003530155451
	28	2.4	2	2,000	294,000	0521470400282	4003530155468
	33	2.4	2	2,000	294,000	0521470400332	4003530155475
	38	2.4	2	2,000	294,000	0521470400382	4003530155529

Acabado cambiado a WIROX.

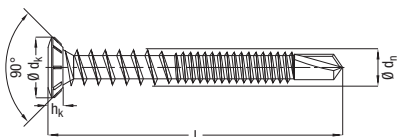

FEX-H, tornillo combinado, especial cabeza plana

Ranura en cruz H, rosca combinada

Nervios de frenado, punta perforadora

Endurecido, revestimiento sintético



A9J

Rosca- \varnothing d_n	Dimensiones [mm]			Unidad de venta		N° SPAX	Cód. EAN
	Longitud total l	Altura de la cabeza h_k	Tamaño Huella H	SPAX Box [uds]	Palé		
Embalaje estándar							
4.2 $\varnothing d_k =$ 7.0 mm	35	2.4	2	2,000	-	35704012501471K1	4003530170317

Acabado cambiado a WIROX.



Cabeza plana con elemento de 166-167
centrado - Titán plata
•FEX - tornillo de acoplamiento 167



CABEZA PLANA

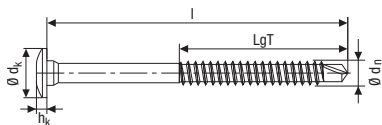

**FEX – tornillo de acoplamiento,
con elemento de centrado,**

T-STAR *plus*, rosca especial. Punta perforadora

Endurecido, revestimiento sintético

Titán plata

A3J

Rosca- Ø	Dimensiones [mm]				Unidad de venta			N° SPAX	Cód. EAN
	Longitud total	Longitud rosca parcial	Altura de la cabeza	Tamaño Huella	SPAX Box [uds]	Embalaje de cartón [uds]	Palé		
d_n	l	L_{gT}	h_k	T					
Embalaje estándar									
	75	40	2.8	25	200	2,000	56,000	1051900550755	4003530188503
5.5 $\emptyset d_K = 12.0$ mm	90	40	2.8	25	200	1,000	56,000	1051900550905	4003530189401



Cabeza con encaje

168-169

- WIROX

• FEX-RS – el tornillo para persianas 169

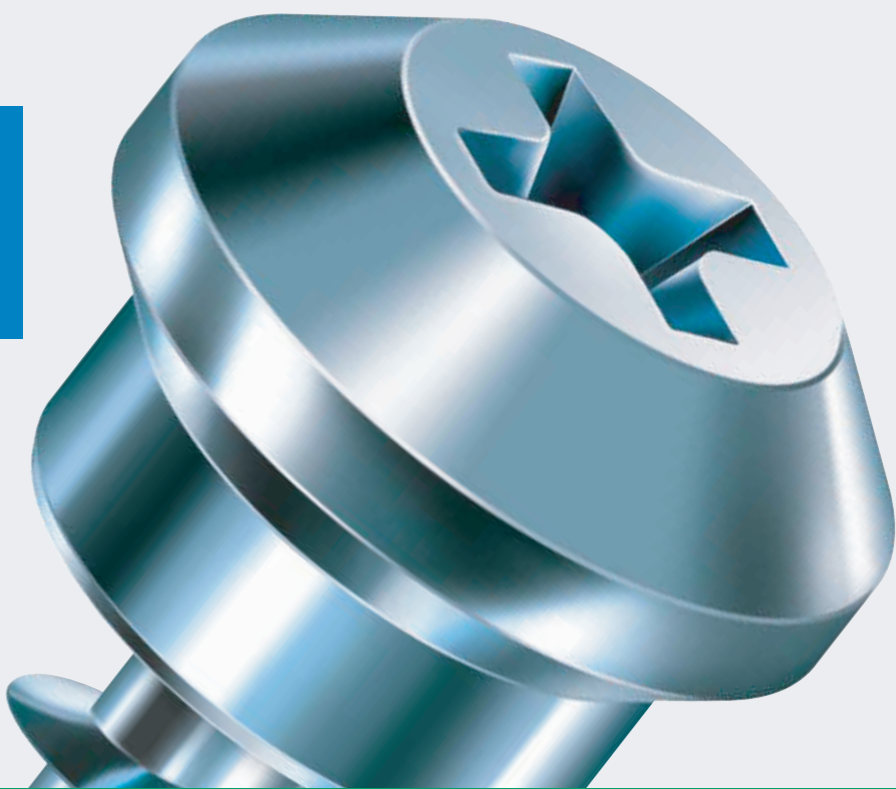

CABEZA CON ENCAJE



FEX-RS, cabeza de centrado

Ranura en cruz H, rosca especial

Con punta de aguja

Endurecido, revestimiento sintético

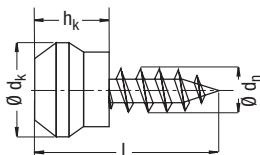

A9J

Rosca- Ø d _n	Dimensiones [mm]						Unidad de venta		N° SPAX	Cód. EAN
	Longitud total l	Cabeza Ø d _k	Altura de la cabeza h _k	Tamaño Huella T	Denominación	Sistema de perfiles	SPAX Box [uds]	Embalaje de cartón [uds]		
Embalaje estándar										
5.0	12	9.5	4.9	2	RS-1	VEKA, Brüggmann	400	4,000	35705003001011	4003530111815
	10	10.4	5.9	2	RS-2	Rehau, KBE, Golde, Inoutic, Helmitin	400	4,000	30120000443011	4003530111754
	10	12.0	5.2	2	RS-3	Trocal, Stöckel, Menke	400	4,000	30120000444011	4003530111761
	11	11.0	7.5	2	RS-4	Kömmerling	400	4,000	30120000442011	4003530111747
	12	11.0	5.8	2	RS-5	Gealan	400	2,000	35705005202011K1	4003530154508
	10	9.5	4.0	2	RS-6	Inoutic	400	4,000	35705006401011	4003530164361



Cabeza cilíndrica

170-171

- WIROX

• Para ventana

-SPAX Anclaje de marcos

171

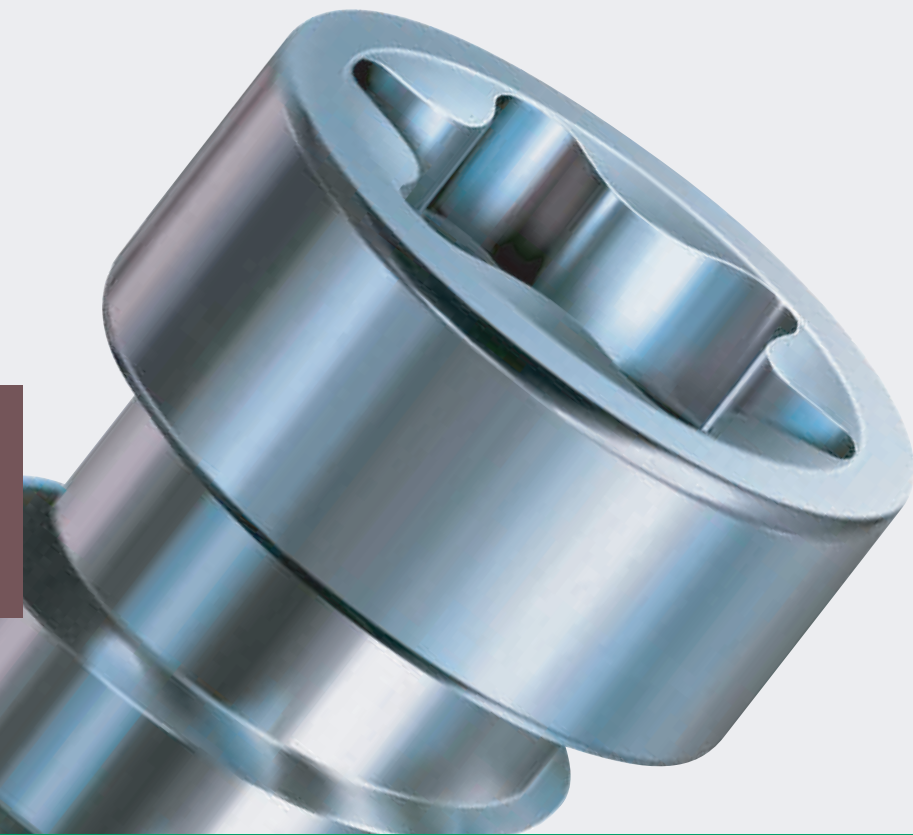

CABEZA CILÍNDRICA

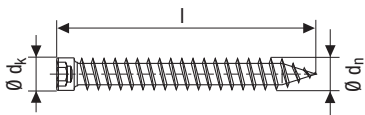

SPAX-RA – Anclaje de marcos, cabeza cilíndrica, T-STAR plus

Endurecido, revestimiento sintético



A9J

Rosca- Ø dn	Dimensiones [mm]		Denominación	Unidad de venta		N° SPAX	Cód. EAN
	Longitud total I	Tamaño Huella T		SPAX Box [uds]	Palé		
Embalaje estándar							
7.5 Ø dk = 8.0 mm	60	30	SPAX-RA 60	100	32,000	1031010750605	4003530181764
	80	30	SPAX-RA 80	100	28,000	1031010750805	4003530181771
	100	30	SPAX-RA 100	100	28,000	1031010751005	4003530181788
	120	30	SPAX-RA 120	100	28,000	1031010751205	4003530181801
	130	30	SPAX-RA 130	100	28,000	1031010751305	4003530181818
	150	30	SPAX-RA 150	100	28,000	1031010751505	4003530181825
	180	30	SPAX-RA 180	100	14,000	1031010751805	4003530181832
210	30	SPAX-RA 210	100	12,000	1031010752105	4003530181849	



Cabeza plana

172-173

- WIROX

• Para ventana

-SPAX Anclaje de marcos

173

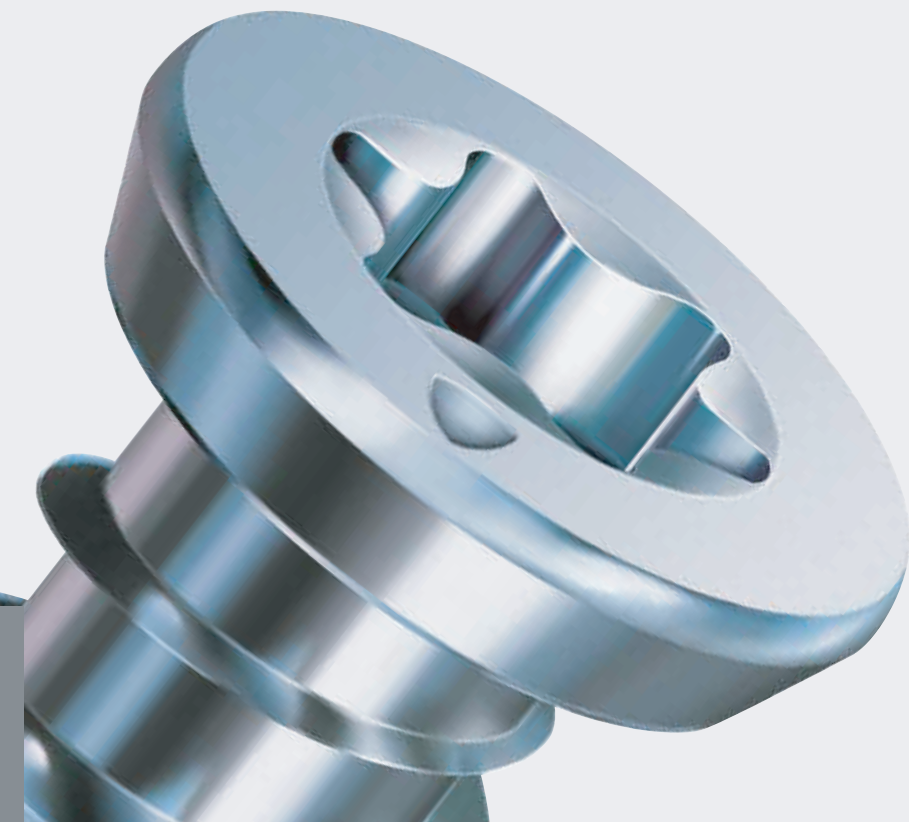

CABEZA PLANA



SPAX-RA – Anclaje de marcos, cabeza plana

T-STAR *plus*

Endurecido, revestimiento sintético

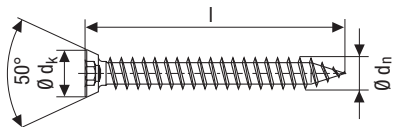

A9J

Rosca- Ø dn	Dimensiones [mm]		Denominación	Unidad de venta		N° SPAX	Cód. EAN
	Longitud total l	Tamaño Huella T		SPAX Box [uds]	Palé		
Embalaje estándar							
7,5 Cabeza plana Ø dk = 11 mm	40	30	SPAX-RA 40	100	32,000	1021010750405	4003530181665
	60	30	SPAX-RA 60	100	32,000	1021010750605	4003530181672
	80	30	SPAX-RA 80	100	28,000	1021010750805	4003530181689
	100	30	SPAX-RA 100	100	28,000	1021010751005	4003530181696
	120	30	SPAX-RA 120	100	28,000	1021010751205	4003530181719
	150	30	SPAX-RA 150	100	28,000	1021010751505	4003530181733
	180	30	SPAX-RA 180	100	14,000	1021010751805	4003530181740
	210	30	SPAX-RA 210	100	12,000	1021010752105	4003530181757



SPAX accesorios: Tapones de plástico para tornillo SPAX RA cabeza plana

Embalaje con 500 uds

Véase pág. 157



Productos de tabiquería en seco	174-179
• GIX TIPO A	176
• GIX TIPO B	177
• GIX TIPO C	178
• GIX TIPO D	179

RESUMEN

GAMA DE PRODUCTOS DE **GIX**[®] TABIQUERÍA EN SECO



Para cada combinación posible de materiales en la construcción de paneles de yeso, tenemos los tornillos correctos en nuestra gama, que llamamos GIX®. Su llamativo color negro es el resultado de la fosfatación, una protección contra la corrosión que garantiza que los tornillos sean resistentes a la humedad.

Nuestros tornillos para paneles de yeso GIX® siempre aseguran que los paneles se mantengan perfectamente en el marco del montante y puedan ser avellanados al milímetro.



GIX® Tipo A, tornillo para yeso, cabeza abocinada,
Ranura en H, rosca fina

Punta de aguja

Tipo A para perfiles metálicos estándar

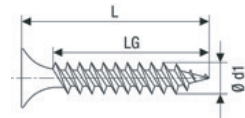

Fosfatado

Rosca Ø	Dimensiones [mm]			Unidad de venta			N° SPAX	Cód. EAN
	Longitud total	Longitud rosca completa LgV	Tamaño Huella	SPAX Box [uds]	Embalaje de cartón [uds]	Palé		
d1	Ls	LgV	H					
Embalaje estándar								
3.9	25	19	2	1,000	10,000	320,000	1091170390255	4003530259623
	35	29	2	1,000	10,000	280,000	1091170390355	4003530259630
	45	39	2	500	5,000	160,000	1091170390455	4003530259647
	55	49	2	500	5,000	140,000	1091170390555	4003530122293

NUEVO

GIX® Tipo A, tornillo para yeso, encintado

Ranura en H, rosca fina

Punta de aguja

Tipo A para perfiles metálicos estándar

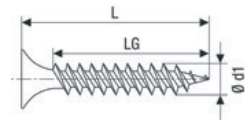

Fosfatado

Rosca Ø	Dimensiones [mm]			Unidad de venta			N° SPAX	Cód. EAN
	Longitud total	Longitud rosca completa LgV	Tamaño Huella	SPAX Box [uds]	Embalaje de cartón [uds]	Palé		
d1	Ls	LgV	H					
Embalaje estándar								
3.9	25	19	2	1,000	-	180,000	1091170390256	4003530259111
	35	29	2	1,000	-	180,000	1091170390356	4003530259128
	45	39	2	1,000	-	180,000	1091170390456	4003530259135

NUEVO



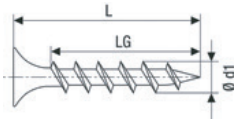

GIX® Tipo B, tornillo para yeso, cabeza abocinada,
Ranura en H, rosca gruesa

Punta de aguja

Tipo B para subestructura de madera

Fosfado

Rosca Ø	Dimensiones [mm]			Unidad de venta			N° SPAX	Cód. EAN
	Longitud total	Longitud rosca completa LgV	Tamaño Huella H	SPAX Box [uds]	Embalaje de cartón [uds]	Palé		
d1	Ls	LgV	H					
Embalaje estándar								
3.9 Ø d _k = 8.3 mm	25	19	2	1,000	10,000	320,000	1891170390255	4003530258664
	30	24	2	1,000	10,000	320,000	1891170390305	4003530259654
	35	29	2	1,000	10,000	280,000	1891170390355	4003530259661
	45	39	2	500	5,000	160,000	1891170390455	4003530259678
	55	49	2	500	5,000	140,000	1891170390555	4003530259685

NUEVO

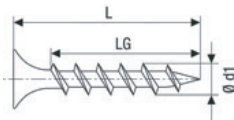

GIX® Tipo B, tornillo para yeso, encintado,
Ranura en H, rosca gruesa

Punta de aguja

Tipo B para subestructura de madera

Fosfado

Rosca Ø	Dimensiones [mm]			Unidad de venta			N° SPAX	Cód. EAN
	Longitud total	Longitud rosca completa LgV	Tamaño Huella H	SPAX Box [uds]	Embalaje de cartón [uds]	Palé		
d1	Ls	LgV	H					
Embalaje estándar								
3.9 Ø d _k = 8.3 mm	25	19	2	1,000	-	180,000	1891170390256	4003530259142
	35	29	2	1,000	-	180,000	1891170390356	4003530259159
	45	39	2	1,000	-	180,000	1891170390456	4003530259166
	55	49	2	800	-	144,000	1891170390556	4003530259173

NUEVO



EN 14560:2020(A1-2009)
Mechanische Befestigungsmittel
für Gips-Plattensysteme
— Drahtschrauben A1
Befestigung: bestanden
(DIN EN 60331)
(download.spax.com)



GIX[®] Tipo C tornillo para yeso, cabeza pequeña plana

Ranura en H, rosca Hilo

Punta de aguja, roscas de fresado

Tipo C para placas de yeso

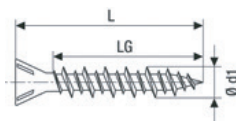

Fosfatado



Rosca Ø	Dimensiones [mm]			Unidad de venta			N° SPAX	Cód. EAN
	Longitud total	Longitud rosca completa LgV	Tamaño Huella	SPAX Box [uds]	Embalaje de cartón [uds]	Palé		
d1	Ls	LgV	H					
Embalaje estándar								
3.9	19	13	2	1,000	10,000	630,000	1791170390195	4003530258633
	22	16	2	1,000	10,000	320,000	1791170390225	4003530258640
	25	19	2	1,000	10,000	320,000	1791170390255	4003530259692
	30	24	2	1,000	10,000	320,000	1791170390305	4003530259708
	35	29	2	1,000	10,000	280,000	1791170390355	4003530259715
	45	39	2	500	5,000	160,000	1791170390455	4003530258657

NUEVO

GIX[®] Tipo C tornillo para yeso, encintado,

Ranura en H, rosca Hilo

Punta de aguja, roscas de fresado

Tipo C para placas de yeso

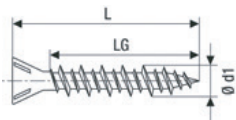

Fosfatado



Rosca Ø	Dimensiones [mm]			Unidad de venta			N° SPAX	Cód. EAN
	Longitud total	Longitud rosca completa LgV	Tamaño Huella	SPAX Box [uds]	Embalaje de cartón [uds]	Palé		
d1	Ls	LgV	H					
Embalaje estándar								
3.9	30	24	2	1,000	-	180,000	1791170390306	4003530259180
	45	39	2	1,000	-	180,000	1791170390456	4003530259197

NUEVO



EN 14562:2008+A1:2009
Mechanische Befestigungsmittel
für Gipsplatten (Stirn-
flanschenlose)
Baugeschäft: bestanden
nach GIB-GIB C.1
(download.spax.com)

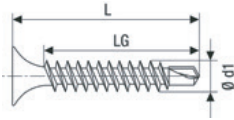

GIX® Tipo D, tornillo para yeso, cabeza abocinada,
Ranura en cruz H

Punta perforadora

Tipo D para perfiles de metal reforzado

Fosfado

Rosca Ø	Dimensiones [mm]			Tamaño Huella	Unidad de venta			N° SPAX	Cód. EAN
	Longitud total	Longitud rosca completa	LgV		SPAX Box [uds]	Embalaje de cartón [uds]	Palé		
d1	Ls		H						
Embalaje estándar									
3.5	25	19	2	1,000	10,000	320,000	1991170350255	4003530259722	
Ø d _k =	35	29	2	1,000	10,000	280,000	1991170350355	4003530259739	
8.3 mm	45	39	2	500	5,000	160,000	1991170350455	4003530258688	

NUEVO

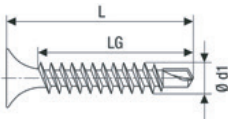

GIX® Tipo D, tornillo para yeso, encintado,
Ranura en cruz H

Punta perforadora

Tipo D para perfiles de metal reforzado

Fosfado

Rosca Ø	Dimensiones [mm]			Tamaño Huella	Unidad de venta			N° SPAX	Cód. EAN
	Longitud total	Longitud rosca completa	LgV		SPAX Box [uds]	Embalaje de cartón [uds]	Palé		
d1	Ls		H						
Embalaje estándar									
3.5	25	19	2	1,000	-	180,000	1991170350256	4003530259203	
Ø d _k =	35	29	2	1,000	-	180,000	1991170350356	4003530259210	
8.3 mm	45	39	2	1,000	-	180,000	1991170350456	4003530259227	

NUEVO



CE
EN 14562:2008(A1-2009)
Mechanische Befestigungsteile
für Gipsplatten-Systeme
Brennwertklasse A1
Baugliedergröße: bestanden
DIN EN ISO 9001
(downloads.spax.com)



DATOS & CIFRAS

EL KNOW-HOW DEL TORNILLO

SPAX video
"Konny's screw
know-how"



Aquí encontrará todo lo que siempre quiso saber sobre tornillos. T-STAR plus, MULTI-Cabeza y 4CUT son el sello distintivo de SPAX y los convierten en algo realmente especial. En la siguiente descripción general, conocerá las diferentes formas de cabeza y las aplicaciones más adecuadas.

También le presentamos los acabados y las diferentes formas de roscas de SPAX. Así como, los campos de aplicación para los que tenemos el SPAX adecuado en nuestra amplia gama de productos.

¿Qué hace que SPAX sea diferente a otros tornillos?

T-STAR plus

Ajuste positivo y seguro del BIT y mejor guiado, en especial cuando trabaje por encima de su cabeza.



MULTI-CABEZA

Avellanado al ras. Avellana en madera y frena en metal



4CUT

Comienza con longitudes de tornillo de 160 mm, su característico moldeado especial al final de la rosca parcial reduce significativamente el par de atornillado.



4CUT

Sin perforación previa (dependiendo de la madera). Su punta reduce efectivamente la rotura. La punta cuadrada empuja a un lado la fibra de la madera y reduce el par de atornillado



¿Qué tipo de cabeza y para qué aplicación?

CABEZA PLANA

Para atornillar tablas a vigas siempre que se requiera un avellanado al ras de la cabeza.

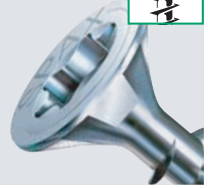

CABEZA REDONDA

Adecuado para accesorios delgados con orificio pre-taladrado. La cabeza redonda se asienta sobre la superficie del material.

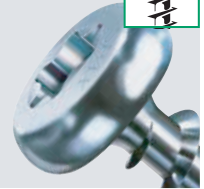

CABEZA GOTA DE SEBO

Cierre decorativo para muebles o accesorios de puertas, zócalos y paneles decorativos. Fácil de avellanar y resultado visual óptimo.



CABEZA ARANDELA

Para atornillar paneles traseros (con pequeñas dimensiones) o cuando se necesiten conexiones realmente seguras, es decir. alta capacidad de carga y altas fuerzas de tracción (con grandes dimensiones de 6-10 mm de diámetro).



CABEZA CILÍNDRICA

Con un diámetro de cabeza pequeño para aplicaciones especiales, por ejemplo: Tornillos de cubierta SPAX.



¿CUÁLES SON LAS CARACTERÍSTICAS ESPECIALES de YELLOX?



RESISTENTE Y SIN EMBARGO NO CONTAMINA GRACIAS A QUE ESTA LIBRE DE CROMO(VI)

- Se logra una mayor protección contra la corrosión en comparación con un recubrimiento de zinc, pero con el mismo espesor de recubrimiento superficial (espesor de recubrimiento de 4–6 µm)
- No contiene cromo (VI) y, por lo tanto, es mucho más ecológico que los recubrimientos de superficie convencionales tanto en producción como en uso.
- Por lo tanto, puede continuar usando un tornillo con una apariencia amarillenta con mayor protección contra la corrosión y sin cromo (VI) (es decir, ecológico y sin problemas de salud) incluso en el futuro
- DIN EN 1670 SPAX con superficie YELLOX optimizada cumple con el Grado 3 ("alta resistencia") según esta norma europea para la resistencia a la corrosión de cerraduras y accesorios.

¿CUÁLES SON LAS CARACTERÍSTICAS ESPECIALES del ACERO INOXIDABLE?



DONDE SON NECESARIOS ESTOS TORNILLOS POR SEGURIDAD:

Los SPAX de acero inoxidable son particularmente adecuados para aplicaciones en exterior.

Están disponibles en la versión **A2** para aplicaciones de exterior expuestas directamente a la intemperie y para aplicaciones en zonas húmedas por ej. cocinas y baños.

Para las zonas costeras se debe utilizar el acero inoxidable **A4**. Se caracteriza por un alto contenido en cromo que forma una capa protectora en la superficie del metal.

Otros elementos de aleación como níquel, molibdeno, manganeso y niobio dan como resultado una resistencia a la corrosión aún mejor

TIPOS DE ACABADO

A2J Galvanizado	A9J WIROX	A2 Acero inoxidable A2 1.4567
A2L YELLOX	P5J WIROX	A2 antik Acero inoxidable A2 bronce
C1A Bronce	E1J Niquelado	A4 Acero inoxidable A4 1.4578

Estas son las
CARACTERÍSTICAS
 especiales de la superficie
 optimizada WIROX.



**LOS BENEFICIOS DE UN VISTAZO:
 NORMA EN 14592**

SPAX con superficie WIROX optimizada satisface completamente los requisitos para la Clase T2 / C2nw de la futura norma EN 14592 para tacos tipo espiga en estructuras de madera. Por lo tanto, ya estamos en condiciones de cumplir con los futuros requisitos europeos. La etiqueta lleva esta abreviatura, como lo exige la norma.

ALTA PROTECCION CONTRA LA CORROSIÓN

En comparación con los tornillos chapados en zinc convencionales, SPAX con superficie WIROX optimizada ofrece una protección contra la corrosión significativamente mayor.

GRAN ESPESOR DE REVESTIMIENTO DE ZINC

El espesor del revestimiento de zinc se ha incrementado en un 25% y ahora es de 10 µm, por lo que los tornillos ahora cumplen los requisitos para la Clase T2 / C2nw según EN 14592.

STANDARD ISO 4042

La abreviatura A9J para el código de la superficie WIROX optimizada según el estándar internacional también está impresa en la etiqueta.

STANDARD EN 1670

SPAX con superficie WIROX optimizada satisface la clase 4 ("resistencia muy alta") de acuerdo con esta Norma europea para la resistencia a la corrosión de construcción de hardware.

ECO-FRIENDLY

WIROX no contiene cromo (VI) y, por lo tanto, es mucho más ecológico que los recubrimientos superficiales convencionales tanto en producción como en uso.



SPAX – CUAL Y PARA QUÉ?

SPAX tornillo para suelo aglomerados

WIROX®

USO

- Fijación de suelos de aglomerado. Por ej., en pisos de madera viejos, por ejemplo durante la renovación de edificios antiguos

CARACTERÍSTICAS

- Rosca de fijación, T-STAR plus
- Superficie WIROX (A9J)

BENEFICIOS

- La rosca de fijación fija el tablero.
- Reduce los agrietamientos



SPAX tornillo para suelos de madera

WIROX®

USO

- Para la colocación de suelos de madera maciza.

CARACTERÍSTICAS

- Punta perforante, T-STAR plus
- 60° cabeza gota sebo, con nervios fresadores
- Superficie WIROX (A9J)

BENEFICIOS

- No hay división de la lengua
- Los nervios fresadores simplifican el avellanado
- Atornillado invisible de tablas de machihembrado



SPAX tornillo cabeza hueca

WIROX®

USO

- Conexión de elementos de mobiliario
- Fijación de zócalos y rieles para cortinas

CARACTERÍSTICAS

- Superficie WIROX (A9J)
- Ranura en cruz Z

BENEFICIOS

- Sin pre-taladro (dependiendo de la madera)
- Procesamiento rápido y seguro
- Ajuste seguro permanente del tapón decorativo



SPAX tornillo para MDF

WIROX®

USO

- Fijación de tableros de fibra (MDF/HDF)

CARACTERÍSTICAS

- punta CUT, T-STAR plus
- Cabeza de fresado pequeña de 75°
- Superficie WIROX (A9J)

BENEFICIOS

- Sin pre-taladro (dependiendo de la madera)
- Reduce efectivamente la rotura y abombamiento del material
- Atornillado de precisión



SPAX ROSCA COMPLETA



Fijación de accesorios con agujeros pasantes, p. ej vigas de madera.

- Absorción de fuerzas de alta tensión por la rosca completa.
- Alta presión de contacto gracias a la rosca completa



SPAX ROSCA PARCIAL



Atornillado de tableros a vigas. La parte sin rosca debe ser al menos tan larga como el grosor del material.

- Fijación segura con espacios reducidos ya que la rosca no se bloquea
- Alta pretensión entre la cabeza y la rosca que se engancha solo en la parte inferior
- Ideal para madera y materiales de madera (por ejemplo, tableros de partículas)



SPAX cabeza arandela, rosca parcial

USO

- Construcción de madera: fijación de listones y madera cuadrada
- Escaleras: fijación de escalones y contrahuellas al larguero de la escalera.

CARACTERÍSTICAS

- Cabeza arandela, rosca parcial, T-STAR *plus*
- Superficie WIROX (A9J)

BENEFICIOS

- Mejor ajuste de las conexiones, incluso con maderas deformadas.
- Protección contra la corrosión significativamente mayor en comparación con los recubrimientos superficiales convencionales
- No es necesario taladro previo (según la madera)

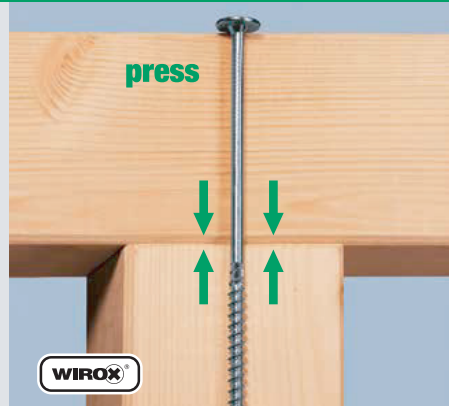

SPAX cabeza cilíndrica, rosca completa

USO

- Construcción de madera: cocheras, pérgolas, etc.

CARACTERÍSTICAS

- Cabeza cilíndrica, T-STAR *plus*
- Rosca completa
- Superficie WIROX (A9J)

BENEFICIOS

- Reemplaza los corchetes angulares
- Refuerzo de tensión lateral: Son posibles altas cargas parciales
- Refuerzo de presión lateral: Se pueden transmitir cargas más altas
- Refuerzo de las conexiones de la varilla.

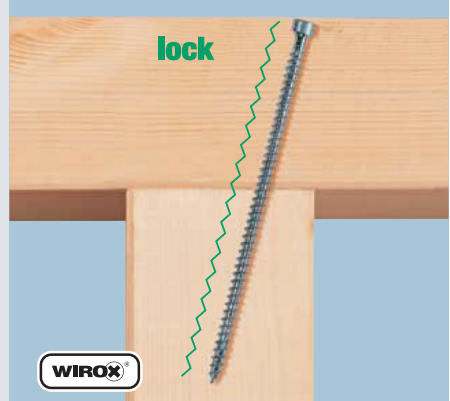

SPAX tornillo para suelo de terrazas

USO

- Particularmente adecuada para cubiertas de madera al aire libre.

CARACTERÍSTICAS

- Acero inoxidable A2 or A4
- Cabeza pequeña cilíndrica, rosca de fijación, T-STAR *plus*

BENEFICIOS

- punta *CUT*
- Fijación segura de la tarima a la subestructura gracias al hilo de fijación.
- Protección permanente contra la corrosión.
- Fácil de atornillar incluso en maderas duras y maderas tropicales *

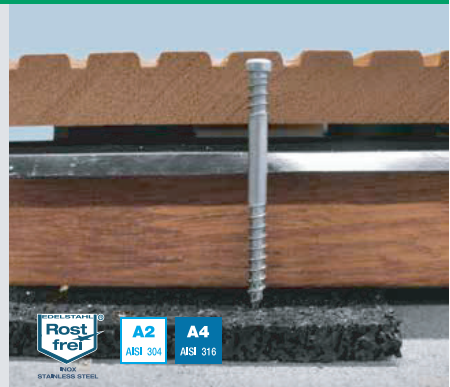

WIROX STAINLESS STEEL



DATOS & CIFRAS

LA ETIQUETA Y SU CONTENIDO

El sistema de guía de etiquetas ayuda a encontrar los productos en el lineal. Toda la información relevante sobre el SPAX se puede encontrar claramente en la etiqueta grande en el frente. El código QR permite obtener información más detallada e instrucciones de uso.

Toda la información importante de un vistazo: **compacta y clara.**

La misma claridad con colores y símbolos recurrentes también se puede encontrar en nuestro catálogo. Búsqueda rápida y sencilla del SPAX requerido.

ESTRUCTURA & SIGNIFICADO

Sistema de código de colores según el tipo de cabeza

Información del producto con detalles como la forma de la cabeza, el tipo de huella, material y/o acabado

Material/ revestimiento de superficie (ej. WIROX A9J)

Pictogramas
Cabeza (ej cab. plana)

Tipo de Huella (ej T-STAR plus)

Punta del tornillo (ej punta 4CUT)



Tornillo universal, cabeza plana,
T-STAR plus, rosca completa
4CUT, MULTI-Cabeza
Endurecido, revestimiento sintético

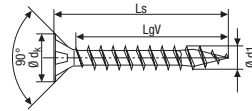

WIROX A9J

Rosca- Ø d1	Medidas [mm]			Unidad de venta			N° SPAX	Cód. EAN
	Longitud del tornillo Ls	Longitud de la rosca LgV	Tamaño de la huella T	SPAX BOX [Uds]	Master carton	Palé		
Embalaje estándar								
3,0* Ø d _k = 1,6 mm	12	10	10	1.000	10.000	1.120.000	1191010300125	4003530105999
	16	14	10	1.000	10.000	1.120.000	1191010300165	4003530106002
	20	17	10	1.000	10.000	630.000	1191010300205	4003530106019
	25	21	10	1.000	10.000	630.000	1191010300255	4003530106026
30	26	10	1.000	10.000	320.000	1191010300305	4003530106026	
Embalaje pequeño								
3,0* Ø d _k = 6,0 mm	12	10	10	200	2.000	470.000	1191010300123	4003530101083
	16	14	10	200	2.000	470.000	1191010300163	4003530101090
	20	17	10	200	2.000	260.000	1191010300203	4003530101113
	25	21	10	200	2.000	260.000	1191010300253	40035301010245
	30	26	10	200	2.000	260.000	1191010300303	4003530101359
Standardverpackung								
	15	11	20	1.000	10.000	630.000	1191010300155	4003530168574
	16	13	20	1.000	10.000	630.000	1191010300165	4003530148040
	20	16	20	1.000	10.000	630.000	1191010300205	4003530168033

Ilustración del producto y la huella e información del tipo de protección sobre la corrosión (ej. T-STAR plus, cabeza plana, rosca completa, WIROX)

Tipo de embalaje (la distinción está realizada entre estándar y embalaje pequeño)



- 1 Diámetro de la rosca
- 2 Longitud
- 3 Huella incluye denominación y código de color del tamaño de la huella
- 4 Cantidad
- 5 N° Artículo
- 6 Cód. EAN
- 7 Ilustración de el producto, información sobre la protección de la corrosión o el número de material con acero inoxidable, número de artículo y código de color.

Código QR para mayor información de producto

BUSCADOR DE TORNILLOS

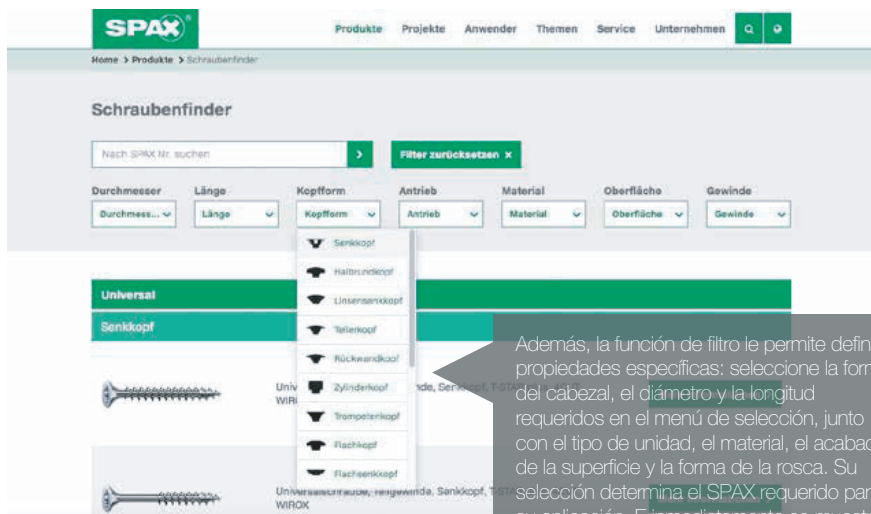

Si conoces el número de artículo SPAX puedes buscarlo directamente.

Además, la función de filtro le permite definir propiedades específicas: seleccione la forma del cabezal, el diámetro y la longitud requeridos en el menú de selección, junto con el tipo de unidad, el material, el acabado de la superficie y la forma de la rosca. Su selección determina el SPAX requerido para su aplicación. E inmediatamente se muestra una lista de SPAX apropiados.

BÚSQUEDA DE DISTRIBUIDORES

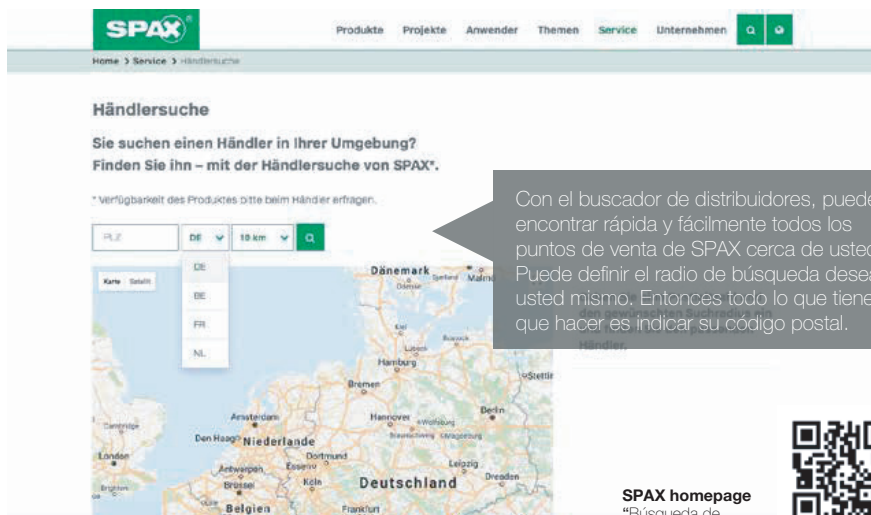

Con el buscador de distribuidores, puede encontrar rápida y fácilmente todos los puntos de venta de SPAX cerca de usted. Puede definir el radio de búsqueda deseado usted mismo. Entonces todo lo que tiene que hacer es indicar su código postal.

SPAX homepage
"Búsqueda de distribuidores"

VIDEOS

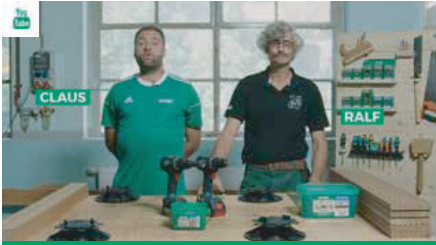

Embajadores de la marca: Claus y Ralf

La manera fácil de construir su propia terraza de madera: Ralf Dammasch y Claus Scholz de Ab ins Beet le muestran cómo se hace.



Las propiedades de SPAX: fijación con calidad

SPAX, el especialista en tecnología de fijación moderna, está firmemente comprometido a ofrecer la más alta calidad en toda su cartera de productos.

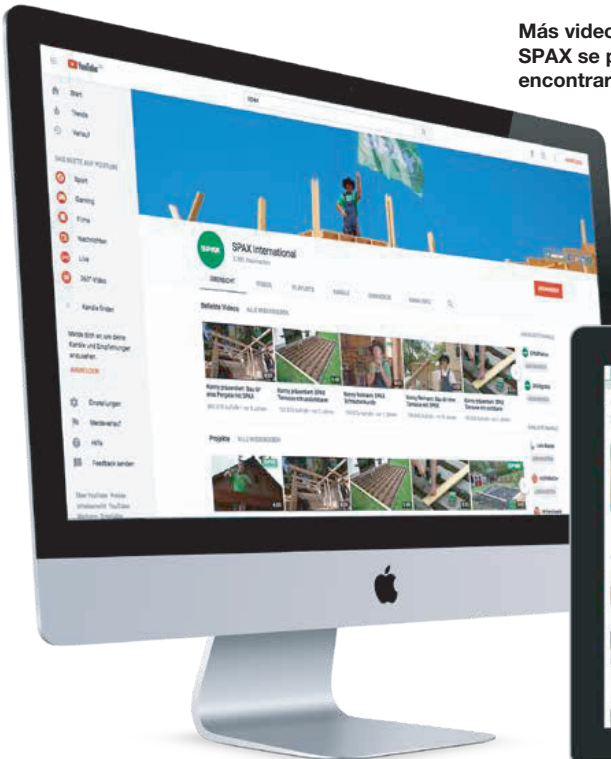

Más videos del mundo SPAX se pueden encontrar aquí:

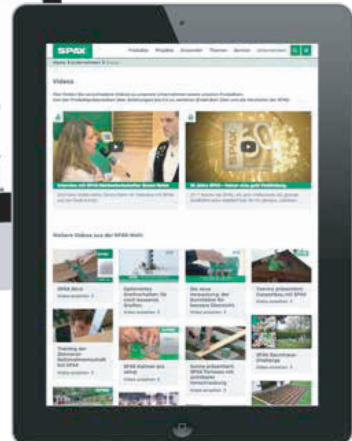

DESCARGAS

SPAX Downloads

Herzlich willkommen in unserem Downloadcenter.
Hier finden Sie umfassende technische Informationen zu unseren Produkten:
wie z.B. Leistungserklärungen (DoP), Zulassungen, Zertifikate, etc...

Anmelden

E-Mail oder Nutzername
E-Mail oder Nutzernummer

Passwort
Passwort
Passwort vergessen?

Zur Estanmeldung

Neu bei SPAX Downloads?
Jetzt schnell, einfach und kostenlos registrieren.

Hemos compilado todos los documentos disponibles para usted en una nueva sección internacional en downloads.spax.com. Dependiendo de su tipo, los documentos están disponibles públicamente o se pueden descargar después de un registro rápido. Los usuarios que ya se han registrado en la sección de descarga anterior pueden continuar utilizando sus datos de acceso existentes sin un nuevo registro.

Startseite | Information | Downloads | Technisches ASB | Kontaktverteilung | www.spax.com

SPAX Downloads

Suche:

Thema:

Unterthema:

Dokumentensprache:

267 gefundene Dokumente

Datum	Thema	Unterthema	Beschreibung	Sprache	Typ
18.07.2017	Zertifizierungen Zulassungen	Europäisch Technische Zulassungen (ETA)	NEF Konformitätszertifikat WPK MPA Stuttgart (07/2017) Zertifikat über die werkseigene Produktionskontrolle Nr. ÜW-OG-51200-DE1. Kopie der Originaldokumente als PDF	Deutsch	PDF (635,79 KB)
17.07.2017	Zertifizierungen Zulassungen	Europäisch Technische Zulassungen (ETA)	NEF Zulassungsbescheid ETA-12/0114 für SPAX-Schrauben (07/2017) European Technical Assessment ETA-12/0114, englische Originalversion, Kopie der Dokumente als PDF	Englisch	PDF (15,48 MB)
17.07.2017	Zertifizierungen Zulassungen	Europäisch Technische Zulassungen (ETA)	NEF Präsentation SPAX mit ETA-12/0114 (07/2017) Informationen zur ETA-Zulassung von SPAX-Produkten als PDF	Deutsch	PDF (25,32 KB)
17.07.2017	Technische Informationen	Englisch/Deutsch	NEF Eingebettete Aufwandsberechnung für passive Dämmstoffe (07/2017) Antragsformular zur statischen Berechnung der Aufwandsberechnung für passive Dämmstoffe mit der SPAX als wiederbeschreibbare pdf-Datei	Deutsch	PDF (1,09 MB)
23.05.2017	Technische Informationen	Bemessungsrichtlinie	Ergänzungsblatt Bemessungsrichtlinie ECS + ETA (03/2017) Hinweise zur Bemessung von tragenden SPAX-Verbindungen. Umfassende Informationen über die Grundlagen der Bemessung und Ausführung, Bemessungsbeispiele, Berechnungsbeispiele und Schnittstellenübersicht. Ergänzungstext auf Grundlage ETA: Bemessungsarbeiten	Deutsch	PDF (3,35 MB)

El portal de descargas de SPAX con todos los documentos disponibles

Puede acceder al portal de descarga directamente en <https://downloads.spax.com>

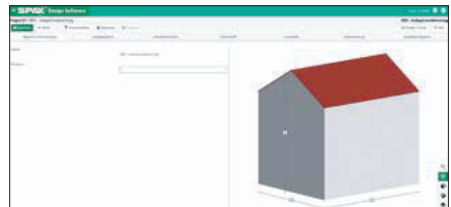

Utilice el software de diseño SPAX para EC5 + ETA también para dimensionar sus proyectos. La nueva versión del navegador ofrece dimensionamiento en línea, i.a. con los módulos Dimensionamiento general de tornillos (corte + pelado), refuerzo de muesca, refuerzo de presión lateral, aislamiento en viga y conexión de haz principal / haz secundario con opción de almacenamiento basado en servidor (alojamiento de archivos) y gestión de proyectos. Se puede encontrar una descripción más detallada del programa en downloads.spax.com en la guía de inicio rápido del software de diseño SPAX. Puede llamar el software directamente en <https://designsoftware.spax.com>

Si lo usa con frecuencia, le recomendamos que establezca un marcador.





MADE IN GERMANY

CERTIFICADOS TESTADO

Cuando se trata de calidad, SPAX no hace promesas. Esto es algo que nuestros clientes saben y aprecian. Desde nuestra instalación de producción "Made in Germany" hasta el monitoreo técnico voluntario por el Instituto de Pruebas de Materiales de Stuttgart.

SPAX opta por la calidad controlada. Esto garantiza la fiabilidad de nuestras conexiones y la completa satisfacción de nuestros clientes.

CERTIFICADOS

Made in Germany

Quien quiera evitar cualquier duda en materia de seguridad no puede comprometer la calidad. SPAX tampoco hará compromisos aquí en el futuro. La calidad y la seguridad en las que puede confiar son las principales prioridades de nuestros elementos de conexión "Made in Germany". ¡Con SPAX siempre estará seguro!



Acero inoxidable

El acero inoxidable SPAX es particularmente adecuado para aplicaciones al aire libre. Están disponibles en acero inoxidable A2 para aplicaciones en exteriores expuestas a la intemperie directa y para aplicaciones en lugares húmedos (por ejemplo, cocinas y baños). Para aplicaciones en áreas costeras, recomendamos la versión de acero inoxidable A4. El acero inoxidable se caracteriza por un alto contenido de cromo, de modo que se forma una capa protectora en la superficie del material. Otros elementos de aleación como el níquel, el molibdeno, el manganeso y el niobio dan como resultado una mejor resistencia a la corrosión.



Aprobación europea

Según una resolución de la Comisión de la UE, el nivel de nuestros productos de acuerdo con el sistema de Evaluación y Verificación de Constancia de Desempeño (AVCP) será revisado y degradado en el futuro de 2+ a 3. Esto se aplica a nuestros productos regulados por un europeo Evaluación técnica (ETA), y por lo tanto con la marca CE. El nivel 3 significa que ya no existe ninguna obligación de monitoreo externo por parte de un instituto de prueba de materiales independiente (organismo de certificación notificado), de modo que un control interno de producción por sí solo es suficiente.

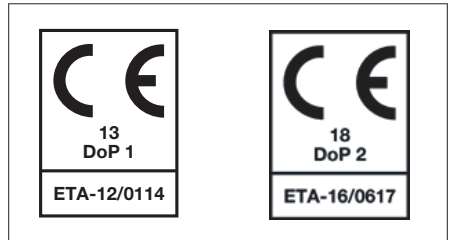

MPA

SPAX se somete a una supervisión técnica voluntaria por parte del Instituto de Investigación y Pruebas de Materiales (MPA) de Stuttgart. Los productos están marcados con esta marca de prueba inequívoca en el embalaje.



SKH

Según el proceso de certificación del sello SKH, el producto y el fabricante son auditados a intervalos regulares por un experto independiente sobre la base de los requisitos definidos.

TÉRMINOS GENERALES Y CONDICIONES

Área de aplicación

1. Estas condiciones de contratación se aplican a empresas, personas jurídicas del derecho público y al patrimonio especial jurídico-público. Estas condiciones de contrato también serán aplicables aun cuando no lo hayamos indicado en cada caso en particular.

Nuestros suministros y servicios se realizan exclusivamente de acuerdo con las condiciones especificadas más abajo. Las condiciones de contratación del cliente sólo serán válidas si las hemos aceptado expresamente y por escrito para la respectiva conclusión de contrato concreta. Si se confirma el pedido de un cliente, discordante con nuestras condiciones de contrato, sólo serán válidas nuestras condiciones de contratación, aun cuando no hayamos formulado expresamente nuestro desacuerdo al respecto. Nuestras condiciones de contratación se considerarán como aceptadas totalmente por el cliente, a más tardar, al aceptar éste nuestro servicio de suministro.

Disposiciones generales

2. Nuestras ofertas son sin compromiso. Los pedidos son vinculantes después de haber sido confirmados por nosotros, a menos que exista un arreglo contractual particular.

3. Los datos e ilustraciones contenidos en ofertas, listas de precios, prospectos, catálogos, etc., son valores aproximativos usuales en el ramo, a menos que hayamos indicado expresamente que estos datos e ilustraciones son vinculantes.

4. Toda información por teléfono o personal será siempre sin compromiso y nula de derecho hasta tanto sea confirmada expresamente por escrito por nosotros.

Contratos a largo plazo y ajuste de precios

5. Nos reservamos el derecho de efectuar un ajuste de precios al producirse alzas imprevistas de los costes, incluso en pedidos aún pendientes.

Confidencialidad

6. Todos los documentos (entre estos también se cuentan muestras, modelos y datos) y conocimientos recibidos por cada parte implicada, procedentes de la relación comercial, se emplearán sólo para los fines perseguidos conjuntamente, y serán tratados confidencialmente frente a terceros con el mismo cuidado con que se tratan documentos y conocimientos propios semejantes, si la otra parte los clasifica como de carácter confidencial o tiene un interés evidente en su confidencialidad. Esta obligación comienza desde que por primera vez se reciben los documentos o conocimientos, y no se extingue incluso después de concluida la relación comercial.

7. La obligación no se aplicará para documentos y conocimientos generalmente conocidos, o que ya sean conocidos por el cliente al recibirlos sin que éste haya estado obligado a guardar secreto, o que luego sean transmitidos por un tercero autorizado para su comunicación, ni tampoco aplica para documentos y conocimientos elaborados por el cliente receptor sin utilizar documentos y conocimientos confidenciales del otro cliente.

Dibujos y descripciones

8. Si una de las partes pone a disposición de la otra dibujos o documentos técnicos sobre la mercancía a enviar o sobre su fabricación, éstos seguirán siendo propiedad de la parte presentante.

Términos de pago

9. Nuestra factura respectiva es pagadera de inmediato y sin deducciones, a menos que se haya acordado algo diferente.

10. Aunque, indiscutiblemente, hayamos suministrado mercancía parcialmente defectuosa, nuestro cliente, no obstante, estará obligado a efectuar el pago de la porción no defectuosa.

11. Por lo demás, el cliente sólo podrá compensar contra reclamaciones comprobadas jurídicamente o incuestionables.

12. En caso de retraso en el pago, a partir del vencimiento, tendremos el derecho a cargar en cuenta intereses a la tasa de interés que el banco nos cobre por créditos en cuenta corriente, como mínimo, no obstante, 8 puntos porcentuales por encima de la respectiva tasa de interés básico del Banco Central Europeo.

Nos reservamos la posibilidad de alegar un mayor daño, en especial, tendremos el derecho a cargar en cuenta 20,00 euros por concepto de tarifa de tramitación por cada recordatoria del pago, más el impuesto sobre el valor añadido oficial vigente.

13. En caso de retraso del pago, tras comunicación escrita dirigida al cliente, podremos suspender el cumplimiento de nuestros compromisos hasta tanto se reciba el importe de los pagos.

14. No se aceptarán letras, y cheques sólo tras acuerdo y únicamente por razones de cumplimiento. Se excluye cualquier garantía de presentación oportuna de cheques así como cualquier responsabilidad por el protesto de cheques.

15. Si después de celebrado el contrato se hace patente que nuestro derecho a pago se ve amenazado por insuficiente capacidad de pago del cliente, podremos entonces rehusar la prestación y darle al cliente un plazo razonable en que deberá pagar gradualmente contra entrega o rendir caución.

Suministro

16. Salvo que se estipule de otro modo, suministramos "ex fábrica". Nuestra notificación de que la mercancía está lista para ser expedida o recogida es determinante para el cumplimiento de la fecha de entrega o del plazo de entrega.

17. El periodo de entrega se prolongará de forma razonable cuando existan las condiciones estipuladas en la cláusula 51. Igualmente el plazo de entrega se prolongará en caso de cierre de la fábrica debido, por ej., a vacaciones de la empresa.

18. Se permiten entregas parciales de volumen aceptable, que serán facturadas por separado.

19. Se permiten envíos incompletos o en exceso, inherentes a la producción, con una tolerancia del 10 por ciento de la cantidad total de la orden. El precio total variará en consecuencia.

Expedición y cesión de riesgos

20. El cliente debe efectuar sin dilación la recepción de la mercancía que haya sido notificada como lista para su envío. De lo contrario, tendremos el derecho a enviarla a nuestra discreción o a almacenarla por cuenta y riesgo del cliente.

21. A falta de acuerdo especial, seleccionaremos el medio de transporte y la vía de transporte.

22. La cesión de riesgos al cliente tiene lugar al efectuarse la entrega de la mercancía al transportista o al comienzo de su almacenamiento, sin embargo, a más tardar al momento en que la mercancía abandona la fábrica o almacén, e incluso, aun

TÉRMINOS GENERALES Y CONDICIONES

cuando nosotros hayamos asumido el envío y hayamos encargado al transportista.

Nosotros contraemos un seguro de transporte o almacenaje sólo por la parte del trayecto de suministro de la que somos responsables.

23. La descarga siempre es una tarea del cliente y se realiza por cuenta y riesgo del cliente.

Demora en el suministro

24. Los plazos de entrega convenidos se prolongarán correspondientemente por causa de cierre de la fábrica debido a días inhábiles o vacaciones de la empresa.
25. Si el suministro se retarda por una de las causas especificadas en la cláusula 67 o por una acción u omisión del cliente, se concederá una prórroga adecuada a las circunstancias.
26. El cliente tendrá el derecho a rescindir el contrato sólo si somos responsables del incumplimiento de los plazos de entrega, y él nos haya establecido, en vano, un plazo de prórroga adecuado.

Reserva de propiedad

27. Nos reservamos la propiedad de toda la mercancía suministrada, hasta el pago definitivo de todos los créditos provenientes de la relación comercial con el cliente. Nuestra propiedad tampoco se extinguirá aun cuando se hayan efectuado pagos por créditos reseñados como especiales.
28. El cliente tiene el derecho a vender las mercancías en despacho ordinario en tanto cumpla puntualmente con sus compromisos derivados de la relación comercial con nosotros. No obstante, el cliente no deberá empeñar ni dar en garantía la mercancía reservada. Él está obligado a asegurar nuestros derechos en caso de una reventa a crédito de la mercancía reservada.
29. En caso de que el cliente no cumpla con sus obligaciones, en especial, en caso de retraso en el pago, tendremos el derecho a rescindir el contrato y a recobrar las mercancías, después de haber transcurrido en vano un plazo razonable concedido al cliente para el pago. Las disposiciones legales sobre la prescindibilidad de la fijación de un plazo quedan intactas. El cliente está obligado a devolver las mercancías. Tendremos el derecho a rescindir el contrato si se solicita la apertura de un procedimiento de insolvencia contra el patrimonio del cliente.
30. Toda eventual elaboración o procesamiento de la mercancía reservada será siempre efectuada por el cliente en nuestro favor. Si la mercancía reservada es procesada con otros objetos que no nos pertenecen o incorporada o combinada de manera inseparable con tales objetos, nos corresponderá la copropiedad del nuevo objeto en función de la relación entre el valor de factura de la mercancía reservada con respecto a los demás objetos transformados o incorporados al momento del procesamiento o incorporación. Si nuestras mercancías son combinadas o mezcladas inseparablemente con otros objetos móviles para formar un producto uniparame, y el otro objeto se debe considerar como objeto principal, el cliente nos transferirá la copropiedad proporcionalmente siempre que el objeto principal le pertenezca. El cliente custodiará la propiedad o copropiedad para nosotros gratuitamente. Por lo demás, para el objeto obtenido a través de la elaboración, procesamiento, combinación o mezcla registró lo mismo que ha sido dispuesto para la mercancía reservada.

31. El cliente nos cede desde ya a título de seguridad todas las rentas y derechos derivados de la venta de mercancías en que nos corresponden derechos de propiedad. Por la presente aceptamos la cesión.
32. El cliente debe informarnos sobre medidas de ejecución a terceros que atañan a la mercancía reservada, a los créditos cedidos u otras seguridades, y proporcionar la documentación necesaria para una intervención. Esto se aplica para todo tipo de perjuicios.
33. Si el valor de las seguridades existentes sobrepasa globalmente los créditos asegurados en más del 20 por ciento, estaremos entonces obligados a desbloquear garantías a nuestra elección cuando el cliente lo requiera.
34. Sólo admitimos devoluciones aceptadas por nosotros previamente.

Reclamación por vicios / defectos

35. La condición de la mercancía se orienta exclusivamente de acuerdo a las indicaciones en nuestros catálogos o en la oferta, o comparado a las especificaciones técnicas acordadas expresamente por escrito con el cliente en el caso específico. En caso de que tengamos que suministrar mercancías de acuerdo dibujos, especificaciones, muestras, etc. de nuestro cliente, éste asumirá el riesgo de la idoneidad de éstas para la aplicación prevista. El momento de la cesión de riesgos es determinante para la condición contractual de la mercancía según la cláusula 22.
36. El cliente o, en caso de suministros directos al cliente final, sus compradores, e igualmente al tratarse de suministros según muestra, deberá(n) comprobar la conparamidad e idoneidad de nuestra mercancía inmediatamente después de su llegada, y reclamar enseguida por escrito y concretamente cualquier suministro defectuoso, erróneo, incompleto o excesivo – los defectos no evidentes se reclamarán inmediatamente después de haberse tenido conocimiento de ellos. En caso de un suministro defectuoso o erróneo, el cliente se abstendrá en el acto de proceder a su procesamiento, elaboración o reventa. La mercancía se considerará como aceptada, siempre y cuando no se haya recibido ninguna reclamación por defectos escrita y concreta, a más tardar después de transcurrir dos semanas; en caso de vicios o defectos evidentes, a partir de la recepción de la mercancía; en caso de vicios o defectos no evidentes, a partir de su constatación. Si ha sido acordada una recepción formal de la mercancía o una prueba de muestra inicial, quedará excluida cualquier reclamación por vicios o defectos que el cliente hubiera podido constatar al efectuar con cuidado la recepción o la prueba de muestra inicial.
37. Para defectos materiales causados por transporte inadecuado o incorrecto, almacenamiento incorrecto, uso, montaje erróneo o puesta en servicio por parte del cliente o de terceros, desgaste habitual, manejo incorrecto o negligente, no somos responsables ni por las consecuencias de cambios inapropiados ni trabajos de reparación realizados por el cliente o por terceros sin nuestro consentimiento. Lo mismo se aplica a los defectos que solo disminuyen ligeramente el valor o la idoneidad de los productos.
38. Las reclamaciones por defectos de material caducan después de 12 meses después de la entrega. Esto no se aplica en la medida en que la ley prescriba períodos más largos, en particular para defectos en un edificio o para bienes que se usaron de acuerdo con su uso habitual y que causaron su defecto.

TÉRMINOS GENERALES Y CONDICIONES

40. Se nos debe dar la posibilidad de constatar el defecto reclamado.

A petición, la mercancía sujeta a reclamo nos deberá ser devuelta sin dilación; nosotros asumimos los gastos de transporte cuando la reclamación por defectos es justificada. Si el cliente no cumple con estos compromisos, pierde todo eventual derecho a reclamación por defectos.

41. En caso de reclamación por defectos justificada, presentada dentro del plazo estipulado, corregimos a nuestra elección la mercancía reclamada o enviamos un sustituto sin defectos.

42. Si no cumplimos con estos compromisos o no los satisfacemos dentro de un periodo de tiempo razonable, el cliente podrá fijarnos por escrito un plazo límite dentro del cual deberemos cumplir nuestros compromisos. Después del plazo transcurrido, el cliente podrá exigir una disminución del precio, rescindir el contrato o efectuar él mismo o encomendar a un tercero las correcciones necesarias, por cuenta y riesgo de nosotros. Una restitución de gastos queda excluida en la medida en que los gastos se incrementen debido a que, después del envío, la mercancía haya sido llevada a otro lugar, a menos que esto se corresponda con el uso prescrito de la mercancía.

43. Los derechos de regreso legales del cliente contra nosotros existirán solamente en la medida en que el cliente no haya celebrado ningún convenio con sus compradores, que vaya más allá de las reclamaciones legales por vicios. Para determinar el alcance de los derechos de regreso también se aplicará la cláusula 37, última frase.

Otros reclamos, responsabilidad

44. A menos que se acuerde lo contrario en lo siguiente, se excluyen otros reclamos adicionales del cliente contra nosotros. Esto se aplica en particular a las reclamaciones por daños y perjuicios sobre la base de la violación de las obligaciones de la obligación contractual y los actos ilegales. Por lo tanto, no somos responsables por daños que no ocurrieron en los productos entregados. En particular, no somos responsables de la pérdida de ganancias u otras pérdidas financieras del cliente.

45. Las limitaciones de responsabilidad antes mencionadas no se aplican en caso de intención, negligencia grave de nuestros representantes legales o ejecutivos de la compañía, así como en el caso de violación culpable de obligaciones contractuales esenciales. En caso de violación culpable de obligaciones contractuales esenciales, somos responsables, excepto en casos de intención o negligencia grave de nuestros representantes legales o ejecutivos de la compañía, solo por cualquier daño previsible contractual típico.

46. Además, la limitación de responsabilidad no se aplica en los casos en que se asume responsabilidad por lesiones a personas y daños a la propiedad de objetos de propiedad privada de acuerdo con la ley que rige la responsabilidad del producto. Tampoco se aplica en caso de daños causados culpablemente a la vida, el cuerpo o la salud de una persona o en el caso de que falten propiedades materiales garantizadas si y en la medida en que dicha garantía tenía el propósito de proteger al cliente contra daños que no ocurrir en los propios bienes entregados.

47. Para la información verbal, en particular la información por teléfono, así como los resultados de cálculo del software de evaluación en línea, no asumiremos ninguna responsabilidad ya que dicha información siempre es no vinculante e ineficaz. Para planificación, consultoría, procesamiento y cualquier otra información asumiremos responsabilidad de cualquier naturaleza

única y exclusivamente si hemos proporcionado nuestras propuestas por escrito al cliente como respuesta a su consulta por escrito de manera vinculante y con referencia a un determinado proyecto que conocemos. Sin embargo, el cliente está obligado a revisar nuestras propuestas él mismo o con la ayuda de expertos cualificados, teniendo en cuenta nuestros productos para el propósito concreto y previsto.

48. En la medida en que nuestra responsabilidad esté excluida o limitada, esto también se aplica a la responsabilidad personal de los empleados, representantes legales y agentes indirectos.

49. Las reglamentaciones legales sobre la carga de la prueba no se ven afectadas.

Limitación

50. Todas las reclamaciones originadas por suministro y prestación prescribirán después de 12 meses, contados a partir de la fecha de la factura.

Fuerza mayor

51. Fuerza mayor, conflictos laborales, disturbios, medidas de autoridades administrativas, incumplimiento de suministros de nuestros proveedores y otros eventos imprevisibles, inevitables y graves, nos eximirán de nuestros deberes de prestación mientras persista la perturbación y en el alcance de su efecto. Esto también es aplicable si los eventos se producen en un momento en que estemos en mora, a no ser que nosotros hayamos ocasionado la mora de forma intencional o gravemente negligente. Estamos obligados, dentro de límites razonables, a proporcionar sin dilación la información necesaria y a adaptar las obligaciones mutuas a las nuevas circunstancias.

Derecho de propiedad industrial/Propiedad intelectual

52. "SPAX" posee derechos de propiedad industrial y derechos de utilización y aplicación sobre derechos de autor en Alemania y en el extranjero (denominados en adelante "Derechos de propiedad industrial"), que se refieren a elementos de unión, en especial, tornillos, puntas y accesorios de herramientas (denominados en adelante "Objetos del contrato"). A petición, es posible consultar un resumen de los Derechos de propiedad industrial, durante el horario comercial normal de "SPAX".

53. En lo que respecta a los objetos del contrato, "SPAX" concede al cliente el derecho no exclusivo, revocable libremente en todo momento, de usar los derechos de propiedad industrial en Alemania, para identificar los objetos del contrato. El cliente está autorizado a utilizar tales derechos concedidos, solamente con fines publicitarios para los objetos del contrato, en particular, en su página web propia. La concesión de estos derechos es libre de regalías.

54. No se permite la concesión de sublicencias a terceros ni la transferencia de derechos de explotación otorgados a terceros. En particular, el cliente registrado no está autorizado a reenviar a terceros archivos de imagen y otros archivos proporcionados por "SPAX".

55. Si el cliente registrado tiene la intención de que un tercero prepare material publicitario, dicho tercero debe registrarse por separado y por escrito con "SPAX". El alcance y la existencia del derecho de explotación otorgado al tercero a modo de exención para fines publicitarios del cliente registrado dependen del alcance y la existencia del derecho de explotación del cliente registrado. El cliente registrado es responsable ante "SPAX" de que el tercero solo ejercerá los derechos de explotación que se le otorguen en el alcance otorgado.

TÉRMINOS GENERALES Y CONDICIONES

55. El cliente registrado garantiza el uso de los derechos de propiedad industrial solo en la forma de representación proporcionada por "SPAX". Siempre deberá indicar que tales derechos son derechos de propiedad industrial, en particular marcas comerciales y derechos de autor, de "SPAX". Dicha indicación debe hacerse exclusivamente de la manera provista y utilizada por "SPAX". En particular, los artículos contractuales solo deben ofrecerse, comercializarse y distribuirse en envases habituales en el comercio y no individualmente. Las imágenes deben tener una referencia. Las imágenes no deben representar el propio logotipo, marca de agua, letras o cualquier otra cosa que no hiciera e inmediatamente, deberá demostrar a "SPAX" a través de presentación de documentos adecuados que los elementos contractuales comercializados y distribuidos por el cliente son de hecho originales bienes "SPAX". Prueba de que los artículos contractuales se obtienen de un mayorista con licencia de "SPAX".
56. El cliente registrado solo comercializará productos "SPAX" originales con derechos de propiedad industrial. Sin haber sido requerido que lo hiciera e inmediatamente, deberá demostrar a "SPAX" a través de presentación de documentos adecuados que los elementos contractuales comercializados y distribuidos por el cliente son de hecho originales bienes "SPAX". Prueba de que los artículos contractuales se obtienen de un mayorista con licencia de "SPAX".
57. El cliente deberá informar a "SPAX" inmediatamente en caso de que conozca la aplicación o el uso de los derechos de propiedad industrial por parte de terceros o si estos usan imágenes que son confusamente similares a los derechos de propiedad industrial. En el caso de una infracción de los derechos de propiedad industrial por parte de terceros, "SPAX" decidirá libremente tomar las medidas necesarias para hacer cumplir sus derechos de propiedad industrial. El cliente no está autorizado a presentar una demanda en su propio nombre por infracción. Si la cartera de derechos de propiedad industrial es atacada por terceros mediante acciones de cancelación o solicitudes de cancelación, es la decisión libre de "SPAX" de defenderse potencialmente de ella.
58. "SPAX" garantiza que los derechos de propiedad industrial en el momento en que se suscribe el contrato están registrados en el registro de derechos de propiedad industrial respectivo, en particular en el registro de marcas, y que "SPAX" es el propietario de los derechos de explotación con respecto a derechos de autor para imágenes. "SPAX" siempre tiene la libertad de decidir si los derechos de propiedad industrial se mantendrán durante la vigencia de este contrato o no.

59. "SPAX" no garantiza que mediante el registro y/o uso de los derechos de propiedad industrial o de autor no se infrinjan derechos de terceros. En el momento en que se celebra el contrato, "SPAX" no tiene conocimiento de ningún derecho de terceros que pueda entrar en conflicto con el registro y/o el uso de derechos de propiedad industrial y derechos de autor. El cliente deberá indemnizar a "SPAX" de cualquier reclamo de terceros que, independientemente de la razón legal, se le acerque al cliente en relación con los artículos contractuales y los derechos de propiedad industrial, a menos que se den intenciones o negligencia grave.
60. El cliente garantiza que una plataforma de Internet operada por él, a través de la cual comercializa, ofrece y distribuye artículos contractuales, corresponde en todo momento con todas las disposiciones legales aplicables del lugar en el que el cliente tiene su sede. En cualquier caso, la exención de responsabilidad se aplicará a "SPAX" como se describe en el artículo 59 mencionado anteriormente, y también de la misma manera y en la misma medida. El cliente no atacará los derechos de propiedad industrial por sí mismo ni apoyará dichos ataques de terceros. Esta disposición no se aplica en países en los que viola la ley aplicable.

Lugar de cumplimiento, jurisdicción y ley aplicable

61. A menos que se determine lo contrario en la confirmación del pedido, nuestro lugar de negocios también es un lugar de cumplimiento.
62. Para todas las disputas legales, incluidos los procedimientos sumarios, el lugar de jurisdicción es el lugar de negocios del demandado.
63. Solo las leyes de la República Federal de Alemania se aplicarán a la relación contractual.
Se excluye la Convención de las Naciones Unidas sobre los Contratos de Compraventa Internacional de Mercaderías del 11 de abril de 1980 (CISG - "Convención de Compras de Viena").

Cláusula de divisibilidad

64. Los acuerdos realizados en el acuerdo en mano corresponden al entendimiento de ambas partes. En caso de que una disposición entre en conflicto con la ley existente, se considera acordado que dicha cláusula será reemplazada por una cláusula que se acerque más a lo que las partes pretendieron y que cumpla con los requisitos legales.

A partir de enero 2020

NOTAS

¡NO TE LO PUEDES PERDER!

REGÍSTRATE AHORA Y RECIBE NUESTRA NEWSLETTER

Regístrate online en spax.com/newsletter





A SPAX NO SE LE LLAMA "INTERNACIONAL" – REALMENTE LO ES!

**La producción se lleva a cabo en nuestro sitio en Ennepetal
y exportamos productos SPAX a más de
40 países en todos los continentes.**

Noe reservamos el derecho de realizar modificaciones sin previo aviso.

SPAX® GOES GREEN!

Apoyamos la impresión
climáticamente neutral en papel de
fuentes responsables, para usted y
para nuestro medio ambiente.

1/2020

© Stangly | www.spax.com

SPAX Tornillería, S.A.U.
GRUPO ALTENLOH, BRINCK & CO - Desde 1823

MADRID
C / Pallier, 52
28914 Leganés
Tel.: 91 693 99 11

BARCELONA
C / Industria, 12
08740 San Andrés de la Barca
Tel.: 93 653 34 00

NOS PUEDES ENCONTRAR EN:

 facebook.com/SPAX.Espana
 instagram.com/spax_spain
 youtube.com/user/SPAXinternational

SPAX Artikel-Nr. 6140

